

# AXOLUTE



**KATALOG**

**2013**



Yeni ürünler

*Beyaz Corian AXOLUTE*



BTicino'dan yeni ayrıcalıklı ürü



AXOLUTE Corian Beyaz





AXOLUTE

MADE WITH  
SWAROVSKI  
ELEMENTS

AXOLUTE  
Nighter/  
Whice

rünler beyazın saflığı, yeni multimedya dokunmatik ekran

Multimedya  
Dokunmatik  
ekran 10"





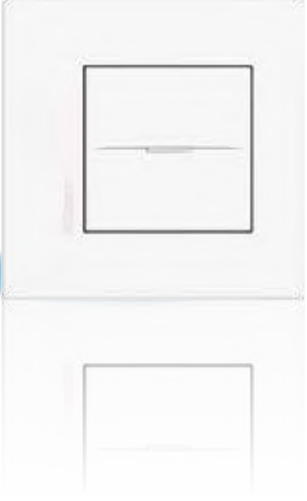

AXOLUTE Etèris

Etèris'in çekiciliği.





## İÇİNDEKİLER



GENEL ÖZELLİKLER	4
Tasarım	5
Teknoloji	35

AXOLUTE ÜRÜN KATALOĞU	51
Anahtar&Prizler	52
MY HOME	79
İnterkom sistemi	121
Çerçeveler: kurulum ve renkler	125

AXOLUTE ETÈRIS	147
Kurulum	148
Katalog	159
Çerçeveler: kurulum ve renkler	162

ÖLÇÜLER	167
---------	-----





Professional



TASARIM



# AXOLUTE

## Tasarım ve teknoloji

➤ AXOLUTE seçkin mekanlar için en iyi çözüm; göz alıcı tasarımı ve MY HOME teknolojisiyle elektrik sistemlerine daha önce olmadığı kadar değer katar.

**AXOLUTE OUTDOOR:**  
BİNALARIN DIŞINA DA  
DEĞER KATAR.



■ **YENİ**

**AXOLUTE BEYAZ:** BEYAZ TUŞ  
KAPAKLARI VE MEKANİZMALAR







**NIGHTER & WHICE:**  
CAMIN EN GÜZEL HALİ



**YENİ**

**AXOLUTE ETÈRIS:** FARKLI TASARIM,  
MİNİMUM KALINLIK, TEK RENKLİ  
GÖRÜNÜŞ



## AXOLUTE ETÈRIS

Yenilikçi ve farklı tasarımın çekiciliği:  
ekstra incelik ve tek renkli görünüş.

➤ Kare şekil, farklı tasarım ve tek renkli görünüş. AXOLUTE ETÈRIS zarif ve kullanışlı tasarımı, tek renkli görünüş ve 2.5 mm'lik inanılmaz inceliğiyle AXOLUTE mükemmelliğini yansıtır.

Ürünün zerafeti ve inceliği anahtarı bulunduğu alanın en önemli unsuru kılar.

SADECE  
2.5 mm





# AXOLUTE ETÈRIS

## Ekstra incelik

➤ Bir anahtar için inanılmaz incelik, eşsiz ve farklı bir çekicilik. Kurulum yapıldıktan sonra kalınlık yalnızca 2.5 mm. İnceliğiyle cazibesi, geometrik lineerliği ve anahtarların asimetrik konumuyla Etèris duvarlarınızın vazgeçilmez bir parçası olacak.

Çerçeve ve mekanizmanın mükemmel uyumu

Keskin kenar

2.5 mm

## Tek renkli görünüş



ANTRASİT ÇERÇEVE



ALÜMİNYUM ÇERÇEVE



BEYAZ ÇERÇEVE

# AXOLUTE ETÈRIS

Kare şekil

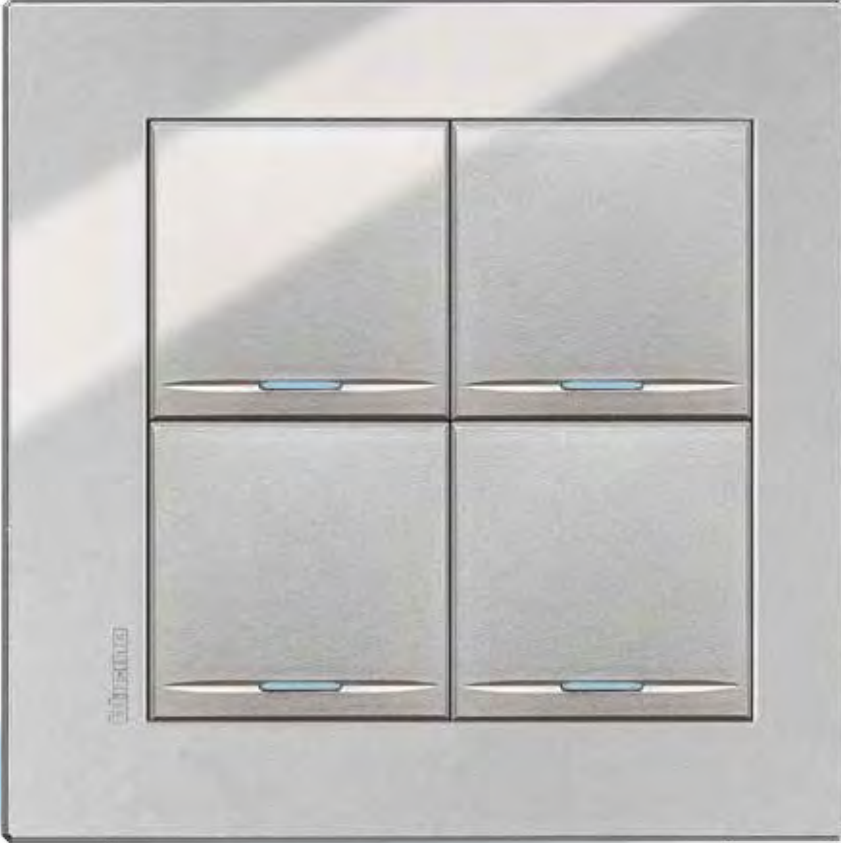

8 MODÜL ALÜMİNYUM ÇERÇEVE

AXOLUTE ETÈRIS anahtarlar için geleneksel düzenlerin ötesine geçmiş yeni bir tarzdır.



2 MODÜL ALÜMİNYUM ÇERÇEVE

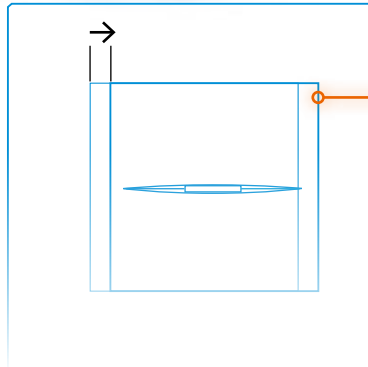

*Kare çerçeve tasarımında anahtarın asimetrik konumu*

# AXOLUTE ETÈRIS

## Uygulamada özgürlük

➤ Kişisel tercih ve fonksiyon ihtiyaçlarına göre 2 modül anahtarlar yatay uygulamalarda yan yana veya dikey uygulamalarda üst üste montaj edilebilir.



*Yatay montaj örneği*

*Çevreveler mükemmel bir şekilde hizalanmıştır.*

*Dikey montaj örneği*





# AXOLUTE ETÈRIS

AXOLUTE işlevleri: gelenekselden dijitale

➤ AXOLUTE ETÈRIS sayesinde elektrik sistemlerini bir sanat eseri olarak yaratmak mümkündür:

- geleneksel ürünler
- MY HOME ürünleri (ev otomasyon)
- Görüntülü interkom sistemleri



GELENEKSEL ÜRÜNLER



MYHOME ÜRÜNLERİ



AXOLUTE ETÈRIS DOKUNMATİK EKРАН

## AXOLUTE ETÈRIS İLE DOKUNMATİK EKРАН VE VİDEO DISPLAY

Katalogda bulunan cihazlarla aynı özellikte fakat AXOLUTE ETÈRIS inceliğiyle.

AXOLUTE ETÈRIS, AXOLUTE  
KATALOĞUNDA BULUNAN  
BÜTÜN MODÜLER ÜRÜNLERLE  
BİRLİKTE KULLANILABİLİR.



AXOLUTE ETÈRIS VİDEO DISPLAY

# AXOLUTE ETÈRIS

## Yeni Anahtar formatları

➤ Kişisel zevkler ve kurulum ihtiyaçlarına göre modülerlik ve sadelik.

2 modül çerçeve: 1 ve 2 modül AXOLUTE ürünleri montajı için

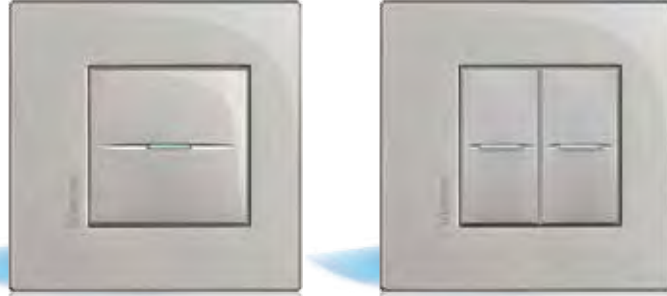

4 MODÜL ÇERÇEVE



8 MODÜL ÇERÇEVE

Farklı modülerliğe sahip 2 çerçeve için aynı ölçü:

- 4 modül: 1 ve 2 modül AXOLUTE ürünleri montajı için
- 8 modül: Bütün AXOLUTE modüler ürünlerin (1, 2, 3 ve 4 modül) montajı için.



AXOLUTE ETÈRIS Video Display ve Dokunmatik Ekran için özel çerçeve

# AXOLUTE ETÈRIS

## Seçkin tasarım çözümü

➤ AXOLUTE ETÈRIS, çok sayıdaki muhteşem özellikleri ve yeni modülerliğiyle özel bir kurulum sistemi gerektirir.

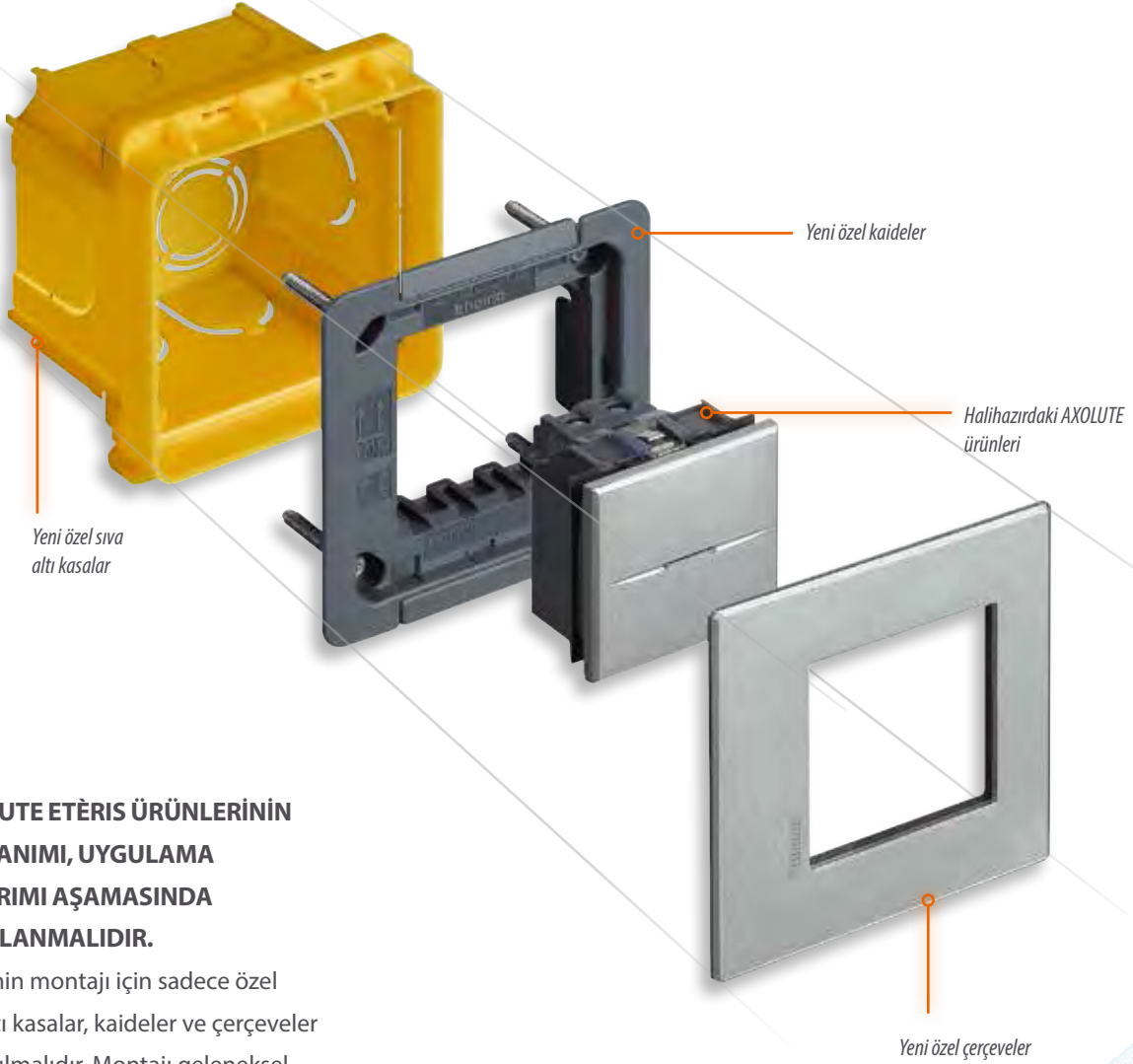

### AXOLUTE ETÈRIS ÜRÜNLERİNİN KULLANIMI, UYGULAMA TASARIMI AŞAMASINDA PLANLANMALIDIR.

Sistemin montajı için sadece özel sıvaaltı kasalar, kaideler ve çerçeveler kullanılmalıdır. Montajı geleneksel kurallara göre yapılmasına rağmen AXOLUTE ETÈRIS ürünleri piyasada bulunan kasalarla uyumlu değildir.





# AXOLUTE

Beyaz Çözüm: zamanı yenileyen zerafet ve saflık

➤ AXOLUTE serisi yeni beyaz mekanizmalar ve çerçevelerle zenginleştirildi; böylece sistemin en güncel dekorasyon stilleri ile uyum sağlayan bir seçenek olması sağlandı.



*Axial anahtar. Beyaz Cam çerçeve*



*Dijital anahtar  
Beyaz Cam*

Mutlak beyaz,  
AXOLUTE beyaz.



*Video Display  
Beyaz Cam çerçeve*

# AXOLUTE

Beyaz Çözüm: yeni beyaz çerçevelerle birlikte kullanılan yeni beyaz anahtarlar

## ➤ Beyaz Çözüm:

- yeni bütünüyle beyaz çerçeveler  
(Corian®, Cam, Alüminyum ve Zamak)
- yeni beyaz anahtarlar

Parlak beyaz  
yüzey

Opal beyaz  
lens

### GLACIER BEYAZ CORIAN® ÇERÇEVE

Maksimum saflık; iç çerçeve  
ve tuşların mükemmel uyum.



Beyaz iç  
çerçeve

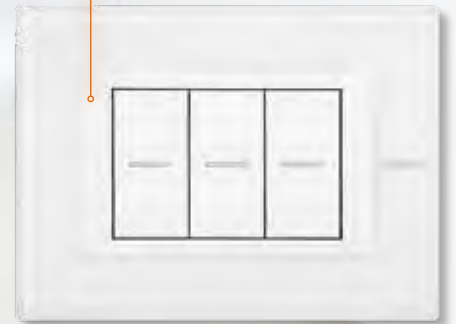

### BEYAZ SATİNE CAM DİKDÖRTGEN ÇERÇEVE

AXOLUTE çerçevelerde krom  
renginde olan iç çerçeve artık  
beyaz.

**Metal, alüminyum ve Zamak**

**çerçeveler**, lake etkisi verecek şekilde beyaza boyandı. Ayrıca, AXOLUTE çerçeve serisinde krom renginde olan iç çerçeveler şimdi beyaz oldu.



AXOLUTE BEYAZ DİKDÖRTGEN ÇERÇEVE



AXOLUTE BEYAZ ELİPTİK ÇERÇEVE

Yeni beyaz anahtar katalogta bulunan AXOLUTE çerçevelerle birlikte kullanılabilir.



ALESSI PARLAK PASLANMAZ ÇELİK



TİK AĞACI



MAT ALTIN

AXOLUTE

El yapımı mücevherler





➤ Swarovski Elements kristallerinin parlaklığı ve AXOLUTE zerafeti ile birlikte bir çerçevede iz bırakmak için kurgulandı.  
Saf ihtişam, anahtarı eşsiz ve mükemmel bir stil ile giydirmek için kullanıldı.



AXOLUTE SWAROVSKI  
ELEMENTS CRYSTAL



AXOLUTE SWAROVSKI  
ELEMENTS LIGHT PEACH

Swarovski Elements kullanılarak oluşturulan çerçeveler bütünüyle el yapımıdır. Özel istekler dahilinde yapılan bu çerçeveler 2, 3, 4 ve 3+3 modül olarak bulunmaktadır.

#### ÇERÇEVE REFERANSLARI

	Crystal	Light peach
2 modül	HA4802SWC	HA4802SWL
3 modül	HA4803SWC	HA4803SWL
4 modül	HA4804SWC	HA4804SWL
3+3 modül	HA4826SWC	HA4826SWL

# AXOLUTE NIGHTER

## Siyah camın başrolde olduğu seçkin çözüm

### > AXOLUTE Nighter

Teknolojinin ve zerafetin en iyi şekilde ortaya çıkarıldığı tek renkli seridir.

Anahtar & prizler, MY HOME ve görüntülü kapı giriş sistemleri siyah cam ve arayüzlere dikkat çeken mavi ledler ile estetik bütünlüğe sağlamaktadır.



*MY HOME sistemi ve görüntülü kapı giriş sistemleri için Nighter Video Station*



*MY HOME sistemi için Nighter kontrol*



*Estetik kordinasyonun sağlanması için Nighter cam çerçevelerle AXOLUTE ANTRASİT renkli mekanizmalar kullanılmaktadır.*

# AXOLUTE WHICE

Beyaz camın başrolde olduğu gelişmiş AXOLUTE serisi

AXOLUTE WHICE tek renkli beyaz çizgisiyle kontrol mekanizmalarının görselliği ile teknolojik gelişmişliği arasında dengeyi sağlar.

Anahtar & prizler, MY HOME ve görüntülü kapı giriş sistemleri beyaz cam ve arayüzlere dikkat çeken mavi LEDLER ile estetik bütünleşme sağlamaktadır.



MY HOME sistemi ve görüntülü kapı giriş sistemleri için Whice Video Station



MY HOME sistemi için Whice kontrol



Estetik kordinasyonun sağlanması için Whice beyaz cam çerçevelerle AXOLUTE ALÜMİNYUM renkli mekanizmalar kullanılmalıdır.

# TASARIM VE İŞLEVSELLİK

## Anahtar özellikleri



➤ AXOLUTE anahtarlarda kusursuz görünüş:

- axial anahtar: anahtarların mükemmel düzlemselliğini sağlamak için
- iç çerçeve: çerçeve rengine göre: krom veya beyaz
- ışık bandı\*: antrasit ve aliminyum mekanizmalar için açık mavi, beyaz mekanizmalar için opal.

Axial anahtar

Işık bandı

İç çerçeve

### SEÇKİN, KARANLIKTAKİ BİLE...

Anahtar ve prizleri karanlıkta da bulmayı kolaylaştıran farklı ve tercihe bağlı ışık (LED teknolojisi).

\* Arka aydınlatma için sadece açık mavi LED kullanılabilir, (kataloğa bakınız)



Işıklı antrasit axial anahtar ve ışıklı kaide

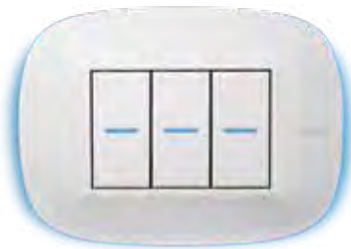

Işıklı beyaz axial anahtar ve ışıklı kaide



Işıklı priz



## Anahtarlar

Birçok anahtar seçeneği sayesinde, kullanıcılar kişisel tecrübelerine ya da tarzlarına uygun olan anahtarı seçebilirler.

### AXIAL ANAHTARLAR

Axial anahtarlarda tuş kapakları her iki pozisyonda da aynı hizada kalır.



Özel koruma kapağı, tüm kurulumlarda kusursuz montaj imkanı sunar.

### DİJİTAL KONTROL

Elektronik kontrollerle, dijital cihazlar geleneksel sistemlerde bile kumanda edilebilir.



Klasik anahtarlar mevcut alışkanlıklarla uyum sağlar.

### STYLE ANAHTARLAR

Çağdaşlık ve gelenekselliğin birlikte varılması anahtara güçlü bir yan katar. Bu birliktelik seride ışıltı yaratır.



# ZARIF BİR GÖRÜNÜŞ

Farklı malzeme, doku ve şekil kombinasyonları



SATİNE

Modern iç mekanların temel malzemesi **ALÜMİNYUM** minimum kalınlıktaki anodize ve boyama çerçevelerin tüm köşelerinin mükemmel kesimi ile zenginleştirilebilir.

**SADE VE ZARIF DİKDÖRTGEN ÇERÇEVELER, AXOLUTE SERİSİNİN RASYONEL RUHUNU YANSITIR.**

Hem yüksek teknolojinin hem de doğallığın simgesi olan **CAM** çerçeveler farklı malzemelerle birlikte kullanılarak, en fazla 4 mm kalınlıkta olmak koşuluyla, benzersiz bir yansıma yaratır.



MAVİ CAM



KIRAZ



TİK

Doğal ve sıcak **AHŞAP** çerçeveler. Birçok **AHŞAP** çerçeve seçeneği ile iç mekanlarda zarif tasarımlar.



CARRARA MERMERİ

**TAŞ**, en yüksek derecede prestiji temsil eder. Doğal malzeme, yüksek teknoloji mekanizmalar ile bütünleşir. Tartışmasız değerinde iki italyan taşı: Carra mermeri ve siyah taş.

**FARKLI TARZLAR YARATMAK İÇİN YUMUŞAK KÖŞELİ ELİPTİK ÇERÇEVELER.**

**PLASTİK**, tasarımın dışı vurumu modern teknolojiler, renkleri zenginleştirir ve çerçeve suyun parlaklığını yansıtır.



LİKİT MAVİ

**DERİ**, yumuşak ve sofistike, teknolojiye doğal ve zarif bir dokunuş katmak için 2 deri çerçeve seçeneği; kum deri ve kahve deri.



KAHVE DERİ

**ALESSİ PASLANMAZ ÇELİK**

Axolute, özel tasarım ev ürünleri üretiminde uzmanlaşmış italyan üreticisi Alessi ile birlikte geliştirilen 2 farklı dokuda metal çerçeve sunuyor: Parlak ve Satine



ALESSİ PARLAK ÇELİK

PARLAK TİTANYUM



**METAL ÇERÇEVELER**, Altın ve gümüş gibi tartışılmaz değerlerin, ince ve klasik işçilikleri mekanizmanın rengiyle uyumlu sunulur.



# ZENGİN GÖRÜNÜŞ

Farklı doku, çerçeve ve görkemin birleşimi

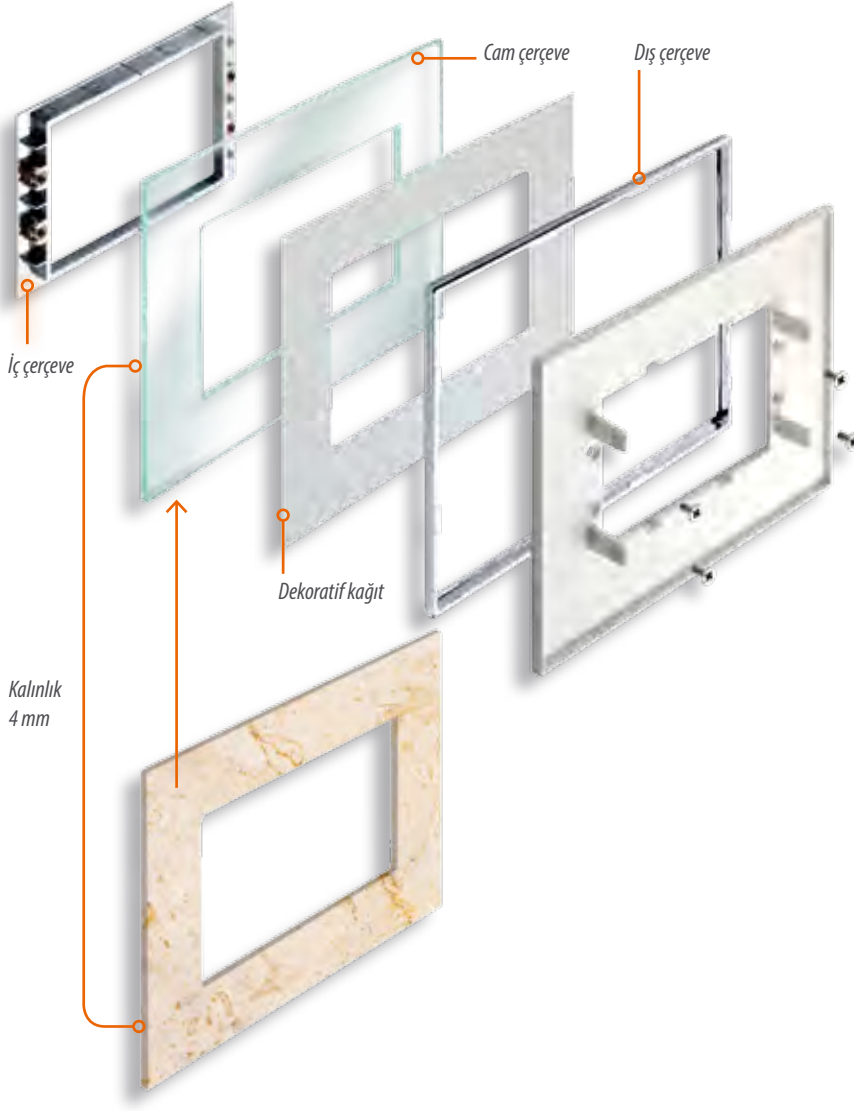

➤ Kristal krom kaplama çerçeve, altındaki dört vida sökülerek kolayca çıkarılabilir. Böylece camın altına, metal folyolar (bakır, altın, gümüş), kumaşlar, işlemler yerleştirilerek olağanüstü yansımalar ve benzersiz etkiler sağlanabilir.

AXOLUTE, malzeme seçiminde de maksimum seçenek sunar: müşteriler arzu ettikleri çerçeveyi yaratmak için, cam çerçeveleri bir şablon halinde kullanarak farklı malzemelerle birleştirebilirler. Böylece, en fazla 4 mm kalınlıkla olmak koşuluyla sonsuz sayıda çerçeve seçeneğine sahip olurlar.

BTicino ve **Graniti Fiandre** işbirliği ile, BTicino çerçeveleriyle dünyanın en prestijli seramik döşemelerinden olan **Graniti Fiandre** kullanılarak, iç mekanlara benzersiz bir uyum getirilebilir.

Ayrıntılı bilgi için:  
[www.granitifiandre.bticino.it](http://www.granitifiandre.bticino.it)  
adresini ziyaret edin

AXOLUTE  
"Graniti Fiandre"





## Çerçeve kombinasyonları

AXOLUTE çerçevelerini 4 farklı kombinasyonda kullanmak mümkündür.

### 1. BASKI

Tek renk ya da renkli logo ve sembollerle tüm çerçeveler kişiselleştirilebilir.



*Tek renk logo baskılı çerçeve*



### 2. İÇ ÇERÇEVE

Krom iç çerçeve seçenekleri: alüminyum ve antrasit (AXOLUTE mekanizma renkleri), parlak yada saten altın, maksimum renk uyumu ve zarafet.



*alüminyum çerçeve ve tuş kapakları ile iç çerçeve*



*Antrasit çerçeve ve tuş kapakları ile iç çerçeve*

### 3. RENKLİ

Özel sipariş durumunda:

- dikdörtgen çerçeveler, eliptik çerçeve renklerinde (alüminyum, antrasit ve siyah)
- eliptik çerçeveler ise dikdörtgen çerçeve renklerinde (beyaz, kırmızı, yeşil ve mavi) temin edilebilirler.

*Sevres yeşili eliptik çerçeve*



### 4. AHŞAP

Dikdörtgen çerçevelerde Akağaç, kiraz ve ceviz ahşap çerçeveler mevcut iken eliptik çerçevelerde venge, Tik ve Dişbudak çerçeveler mevcuttur. Maun, meşe ve armut ağacı ahşap çerçeveler ise her 2 şekilde de mevcuttur.



*Dikdörtgen çerçeve, ceviz ağacı*

**NOT:** Yukardaki kombinasyonlar, özel siparişlerle yapılır. Tüm modüler uygulama, doku ve çerçevelerde sipariş verilebilir. Teslim süresi, sipariş verildikten sonra 6-8 hafta içerisinde. Ayrıntılı bilgi ya da özel siparişleriniz için lütfen satış ofislerimize başvurunuz.

# AXOLUTE: ULUSLARARASI BİR STANDART

## Alman standartı

MERKEZLER ARASI MESAFE 71 mm

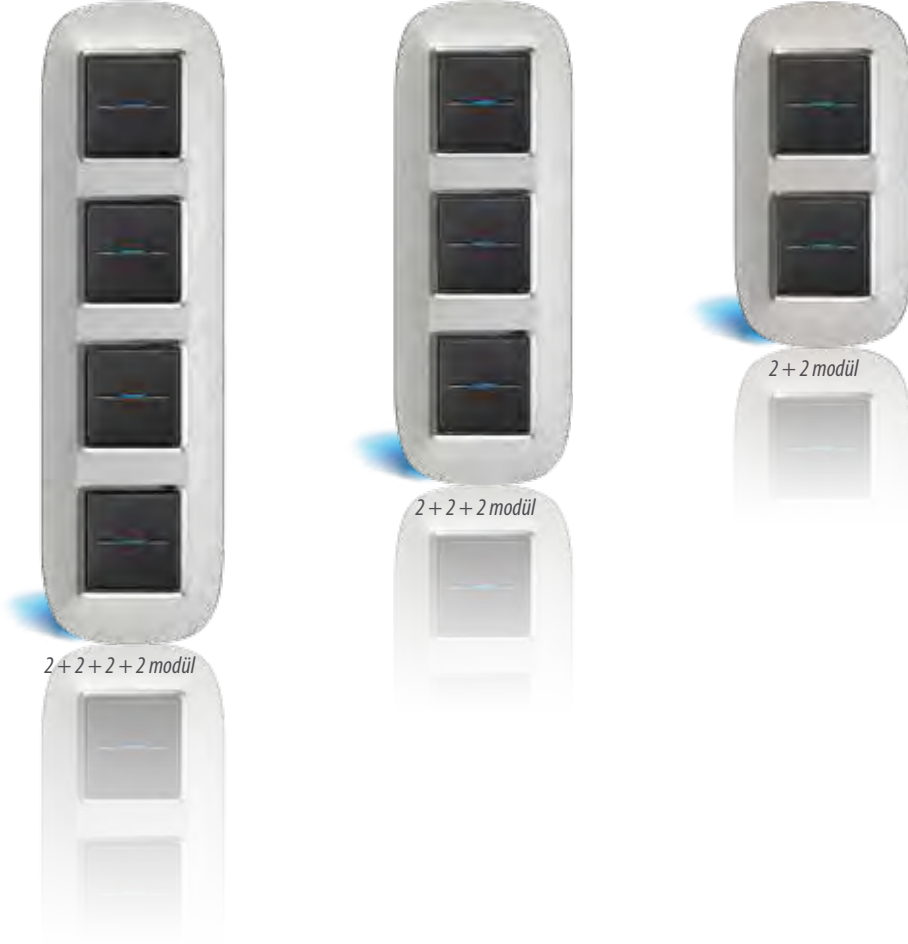

## İtalyan standardı



2 modül



3 modül



4 modül



6 modül



3+3 modül

# AXOLUTE OUTDOOR

Dış mekanlarda tasarım ve teknoloji



**PRESTİJLİ VE MODERN  
MEKANLAR İÇİN ÇELİK ÇERÇEVE**

➤ Gelişmiş teknoloji ve çeliğin çekiciliği, benzersiz tasarımlı modern yapılarda kullanılmak üzere bir araya getirilmiştir.





## KLASİK MEKANLAR İÇİN PİRİNÇ ÇERÇEVE

➤ Gelişmiş teknoloji ve keskin olmayan köşeler. Klasik mekanlarda kullanılmak üzere, gelişmiş teknoloji ve yuvarlak hatlar, pirincin kattığı değerle bir araya getirilmiştir.



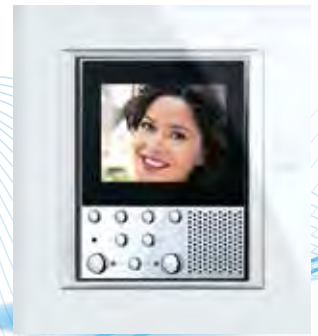



TEKNOLOJİ

# AXOLUTE MY HOME

## İşlevler

➤ MY HOME BTicino'nun ev otomasyonu çözümü; elektrik sistemleri yaratmanın yeni yolu.

### GELİŞMİŞ ELEKTRİK SİSTEMLERİ

MY HOME teknolojisi sayesinde artık konfor, güvenlik, enerji tasarrufu, sesli görüntülü iletişim ve yerel veya uzaktan kontrol gibi gelişmiş özellikleri içeren elektrik sistemleri tasarlamak mümkündür.

### İŞLEV SEÇİMLERİ

Eviniz MY HOME sistemiyle kurulmuş ise küçük, düşük maliyetli müdahalelerle sistem herhangi bir zamanda genişletilebilir: tasarım aşamasında hangi fonksiyonların öncelikli olduğu ve hangilerinin ilerki tarihlerde yapılabileceğine karar verilmelidir.



### ENERJİ YÖNETİMİ

- Sıcaklık kontrol
- Yük yönetimi
- Tüketim göstergesi



### GÜVENLİK

- Hırsız alarm
- Teknik alarmlar
- Uzaktan yardım
- Kamera görüntüleme sistemi



### KONFOR

- Aydınlatma otomasyonu
- Jaluzi ve farklı otomatik kontrol

**AÇIK BİR SİSTEM**

MY HOME farklı markaların ürünleri ile entegrasyona ve dış dünya ile TCP/IP protokol ile iletişime imkan sağlayan açık bir sistemdir.

**KOLAY TEKNOLOJİ**

MY HOME, dijital BUS, konut veya hizmet sektörlerinde kullanılabilen kolay bir teknolojiyi temel almaktadır.

**SESLİ GÖRÜNTÜLÜ İLETİŞİM**

- Senaryo kontrol
- Müzik yayın sistemi

- Dijital interkom sistemi
- Video telesekreter
- Telefon sistemi

**ENTEGRASYON VE KONTROL**

- Kullanıcı arayüzü ile entegrasyon
- PC veya TV üzerinden kontrol
- MY HOME WEB hizmeti ile uzaktan yönetim

# AXOLUTE MY HOME

Her türlü ihtiyaç için bir arayüz

## HER TÜRLÜ İHTİYACA EN UYGUN ÇÖZÜMÜ SAĞLAYACAK KONTROL ÜRÜNÜ SEÇENEKLERİ

En basit kontrolden senaryo kontrolüne, oda kontrolünden uzaktan kontrole.



### DİJİTAL ANAHTARLAR

İşlev kontrolü için basit bir dokunuş



### DOKUNMATİK ANAHTARLAR

Basit bir dokunuşla ayarlama veya aç/kapa kontrolü.



### DOKUNMATİK EKРАНLAR

Bütün MY HOME işlevlerinin tek bir noktadan kontrolü.

AXOLUTE ve MY HOME,  
her türlü ihtiyaç için dijital  
arayüzler.





### GÖRÜNTÜLÜ İNTERKOM SİSTEMİ

Görüntülü dahili üniteler aynı zamanda MY HOME sisteminin yönetim merkezidir.



### MULTİMEDYA DOKUNMATİK EKKRAN

10" ekran üzerinden ikonlara basit birer dokunuşta MY HOME sistemini görüntülemek ve kontrol etmek oldukça basittir. Aynı zamanda görüntülü dahili ünite olarak kullanıldığında ev içerisinde ve dışarısında bulunan kameraları görüntüleyebilirsiniz.

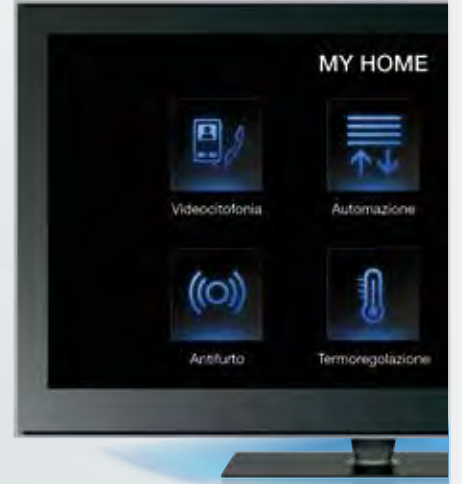

### MULTİMEDYA ARAYÜZ

TV üzerinden harici cihazlardaki multimedya içeriğin yönetimi.



# MY HOME AXOLUTE

## Konfor

➤ MY HOME yaşam alanlarını kolaylaştırır ve kalitelerini artırır. MY HOME ile panjur/stor otomasyonu, merkezi aydınlatma kontrolü, tüm evin merkezi müzik yayın sistem kumandası, sıcaklık kontrolü ve birçok otomasyon uygulaması gerçekleştirilebilir.

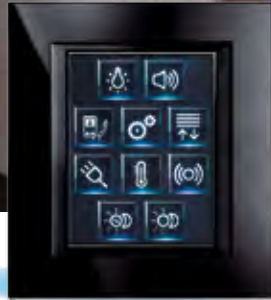

**DOKUNMATİK EKLAN**, dokunmatik ekran üzerinden tüm ev otomasyonu işlevlerinin kontrolü.



**SENARYO KONTROL ANAHTARI**, önceden programlanmış "dinlenme, uyanma, okuma, TV izleme" gibi senaryoları kullanarak tek bir dokunuşla, aydınlatma, sıcaklık ve müzik gibi oda koşulların istenilen seviyeye getirebilirsiniz.

**YENİ****DOKUNMATİK EKРАН**

Dokunmatik ekran:

- Müzik yayın sisteminde amplifikatörlerle on/off, ses ayarı ve kanal seçimi;
- Otomasyon sisteminde, aydınlatma ve perde kontrolü.

**SIVA ALTI STEREO**

**AMPLİFİKATÖR**, müzik yayın sistemlerinde on/off, ses ayarı, kaynak seçimi, kanal veya CD parça seçiminde kullanılır.

**YENİ****GÜÇ AMPLİFİKATÖRÜ**

F503 stereo amplifikatör ile yüksek ses kalitesine sahip olabilirsiniz. Ekolayzır ayarları ile farklı ton ve düzeylerde kullanıcıların ihtiyaçlarına

cevap verir. Gelişmiş OLED ekranda bütün parametreler görüntülenebilir.



# AXOLUTE MY HOME

## Mekana göre enerji tasarrufu

➤ MY HOME enerji kaynaklarının akıllı bir şekilde doğaya zarar vermeden kullanılmasına çok dikkat eder. Enerji tüketim seviyelerinin

görüntülenmesi ve iklimlendirme sisteminin bütün ev içerisinde bölgesel kontrolü.

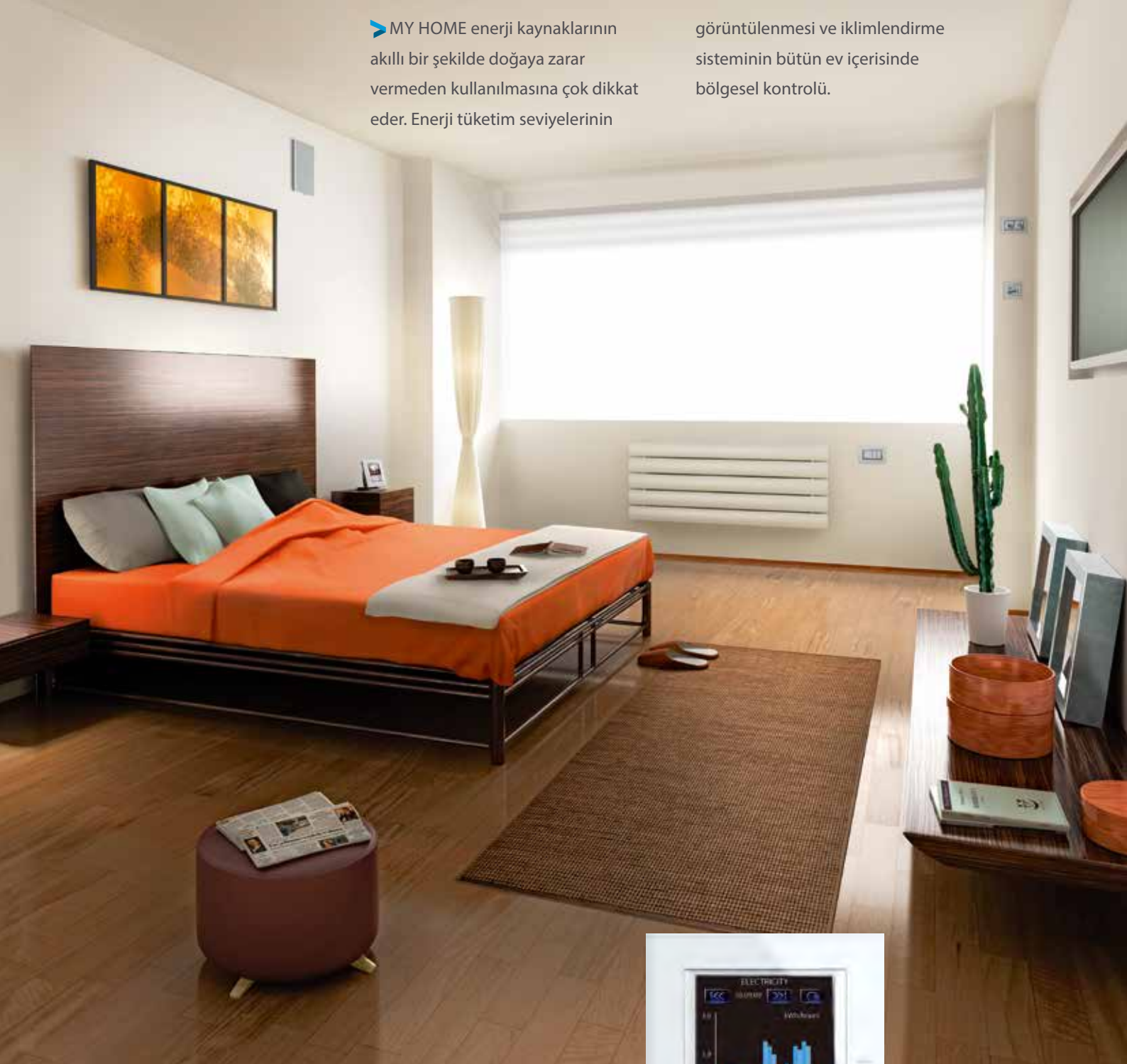

### TÜKETİM KONTROLÜ

Elektrik, gaz ve su tüketim seviyelerinin anlık görüntülenmesi ve izlenmesi.



TÜKETİM GÖSTERGESİ  
DOKUNMATİK EKREN

YENİ



**BTICINO SICAKLIK KONTROL  
SİSTEMİYLE****%30'A KADAR  
TASARRUF SAĞLAYABİLİRSİNİZ**

- Kullanılmayan odalarda iklimlendirmeyi kapatabilirsiniz
- Güneşten sağlanan sıcaklıktan yararlanabilirsiniz
- Fan-coil hızını otomatik olarak kontrol edebilirsiniz



ODA TERMOSTATI

**TERMOSTATLAR**

Her bir zona termostat yerleştirerek, bütün odaların sıcaklıkları ölçülebilir ve merkezi ünite üzerinde ayarlanmış sıcaklığı oda için değiştirebilirsiniz.

99 ZON  
SICAKLIK  
MERKEZİ ÜNİTE4 ZON SICAKLIK  
MERKEZİ ÜNİTE**MERKEZİ ÜNİTELER**

Bu ürünlerle sistem konfigüre edilir, programlar oluşturulur ve bilgiler görüntülenir. Sıva altı 4 zon ve duvara montaj 99 zon olmak üzere iki farklı versiyon bulunur.

# AXOLUTE MY HOME

## Güvenlik



### SIVA ALTI KAMERA

Ev içerisinde görüntüleme yapmak için.



➤ MY HOME siz evde olmadığınızda da evinizi korur ve daha güvenli bir hale getirir. Evinizi izinsiz girişlerden, su, gaz kaçağından korur.

STOP&GO



### STOP&GO KURMA

Devamlı enerji altında kalması istenen yerlerin herhangi bir kaçak akım sebebiyle enerjisiz kalmasını önlemek için.



HIRSIZ ALARM  
MERKEZİ ÜNİTE

### HIRSIZ ALARM SENSÖRLERİ

Yabancılara karşı koruma. Aynı zamanda kapılar ve pencereler için çevresel sensörler de mevcuttur.



DUAL-TEKNOLOJİ  
SENSÖRLERİ



SU BASKINI  
SENSÖRÜ

### TEKNİK ALARM SENSÖRLERİ

Su sızıntılarından kaynaklı su baskınlarına ya da gaz kaçağına karşı koruma.



### UZAKTAN KONTROL

İnternet ya da telefon üzerinden sistemi uzaktan kontrol edebilir ve yönetebilirsiniz.



# AXOLUTE MY HOME

## Video kapı giriş sistemleri

➤ MY HOME, ev içerisindeki tüm data, müzik ve resimlerin yönetimi için kullanılabilir. Ayrıca local video

görüntüleme erişim: kolaylaştırma gibi işlevlerinde yerine getirir.



### DAHİLİ ÜNİTELER

#### VIDEO DISPLAY

- 2.5" renkli display
- İkon menu
- AXOLUTE tasarımı ile uyumlu çerçeveye
- 506E buatlara sıva altı montaj
- hem 2 kablolu sistemlerde hem de MY HOME video kapı giriş sistemlerinde kullanılabilir.



### NIGHTER & WHICE

- 8" renkli display
- 8 mm kalınlıkta cam yüzey
- Sıva üstü montaj: minimum kalınlık
- Dokunmatik klavye; ledlere hafif bir dokunuşla işlevler aktif olur.
- Hem 2 kablolu sistemlerde hem de MY HOME video kapı giriş sistemlerinde kullanılabilir.

### GİRİŞ PANELLERİ

#### AXOLUTE OUTDOOR

- Arka plandan mavi LEDlerle aydınlatılmış alfanümerik klavye üzerinden, cep telefonlarından yapıldığı gibi listeden kişi seçilebilir.
- Tuşlar basit bir dokunuşla aktif hale gelir.
- Alfanümerik klavye üzerinden nümerik bir kod ile kişiler direkt aranabilir.
- Elektronik modül ön yüzündeki cam, yüksek koruma seviyesine sahiptir ve güncel iç-dış mekan tasarımları ile uyumludur.





## Kontrol ve entegrasyon

BTicino MY HOME sistemi, güvenlik ve konfor açısından bir evin tüm görüntülenme ve takip sistemini sağlar. Kumanda mekanizmaları dokunmatik ekran üzerinden bölgesel olarak aktive edilebildiği gibi bilgisayar, telefon ya da cep telefonu kullanılarak uzaktan da aktif edilebilir.



### YENİ

#### LOCAL DISPLAY

Müzik yayın sistemi, sıcaklık kontrol, aydınlatma ve panjur/stor kontrolü için dokunmatik ekranlı display kontrol.



### YENİ

#### MULTİMEDYA DOKUNMATİK EKLAN

Tüm MY HOME işlevleri için video dahili ünite ve kontrol paneli. USB port, hafıza kartı ve PC için mini USB ile multimedya merkezi olarak da çalışabilir.

#### SENARYO PROGRAMLAYICI

Yeni senaryo programlayıcı, MY HOME senaryolarının ve programlanmış ayarların kaydedilmesine izin verir. Basit bir dokunuşla senaryolar aktif edilebilir ya da kaldırılabilir.



### YENİ

#### WEB SERVER

Kurulu MY HOME sistem ya da lokal ağa veya MY HOME Web servisine bağlı kişisel bilgisayar üzerinden takip ve kontrol edebilmeye izin verir.



# MY HOME

## Multimedya

### MULTİMEDYA DOKUNMATİK EKKRAN

10" ekran üzerindeki ikonlara hafif bir dokunuşla, tüm MY HOME



Multimedya dokunmatik ekran üzerinden kontrol edilebilen işlevler:



#### AYDINLATMA

Bir evdeki tüm aydınlatma noktalarının otomatik yönetimi



#### HIRSIZ ALARM

Hırsız alarm sistemini etkinleştirme, kapama ve bölgelere ayırma seçeneklerine sahiptir.



#### PANJUR/STOR

Panjur/stor ve perdelerin otomatik yönetimi



#### SICAKLIK KONTROL

Bir evdeki tüm alanların ısı yönetimi ve merkezi kontrolü



#### MULTİMEDYA

USB/SD web radyo, internetten rss içeriklerini kullanarak müzik, fotoğraf ve video gibi multimedya dosyalarının yönetimi



#### SENARYOLAR

Temel ve gelişmiş senaryoların programlanması ve yönetimi



#### VIDEO EV TAKİP SİSTEMİ

Tüm iç ve dış kameraların kontrolü



#### MÜZİK YAYIN SİSTEMİ

Multimedya ve tüm ses kaynaklarının yönetimi



#### VIDEO KAPI GİRİŞ SİSTEMİ

Giriş panel çağrılarının görüntülenmesi

## MULTİMEDYA ARAYÜZ

Nighter and Whice Video ünitesi MY HOME sistemine entegre edilerek tüm sistemin kontrol noktası durumuna gelir. Ayrıca geleneksel Video üniteleriyle karşılaştırıldığında, Nighter and Whice **multimedya arayüz**, ile birlikte multimedya içeriklerin ve bilgisayar, DVD gibi harici cihazların yönetimine imkan tanır.



Plazma ya da LCD TV

DVD, MP3 player, bilgisayar gibi cihazlarla, bu cihazları MY HOME sistemi **multimedya arayüz** aracılığıyla bağlantı kurmak mümkündür.



PC

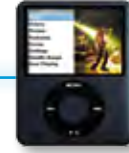

MP3

## BTICINO İŞLEVLERİ



Video kapı giriş sistemi: AXOLUTE Nighter and Whice Video Station



Multimedya arayüz



Video kapı giriş sistemi: AXOLUTE Outdoor

Multimedya arayüz menüsü, televizyonu Nighter and Whice Video ünitesi gibi kullanarak görüntülenebilir ve yönetilebilir.





**İÇİNDEKİLER****ANAHTAR & PRİZLER**

Temel kontrol mekanizmaları _____	52
Röleler _____	59
Işıklı sembolü tuş kapakları _____	60
Dimmer _____	61
Sıcaklık kontrol _____	62
Elektronik kontrol mekanizmaları _____	63
Prizler _____	65
TV, FM ve SAT prizleri _____	67
Sesli ve görsel sinyalizasyon cihazları _____	71
Elektriksel güvenlik mekanizmaları _____	73
Gaz dedektörleri _____	74
Işıklı kaideler _____	75
Boşluk kapakları _____	76
Aksesuarlar ve ampuller _____	77

# TEMEL KONTROL MEKANİZMALARI

## SEÇİM TABLOSU

	AXIAL ANAHTARLAR		STYLE ANAHTARLAR	
	Vidalı bağlantı 1 modül	2 modül	Vidalı bağlantı 1 modül	2 modül
<b>BEYAZ</b>				
<b>ALÜMİNYUM</b>				
<b>ANTRASİT</b>				

Tanım

Anahtar		HD4001	HD4001M2	HZ4001	HZ4001M2
16A250V a.c.		HC4001	HC4001/2	HX4001	HX4001/2
		HS4001	HS4001/2	HY4001	HY4001/2
<b>Vavien</b>		HD4003	HD4003M2	HZ4003	HZ4003M2
16A250V a.c.		HC4003	HC4003/2	HX4003	HX4003/2
		HS4003	HS4003/2	HY4003	HY4003/2
<b>Permütatör</b>		HD4004	HD4004M2	HZ4004	HZ4004M2
16A250V a.c.		HC4004	HC4004/2	HX4004	HX4004/2
		HS4004	HS4004/2	HY4004	HY4004/2
<b>Liht butonu</b>		HD4005	HD4005M2	HZ4005	HZ4005M2
(NA) 10A 250V a.c.		HC4005	HC4005/2	HX4005	HX4005/2
		HS4005	HS4005/2	HY4005	HY4005/2

BEYAZ renkli mekanizmalar

ALÜMİNYUM renkli mekanizmalar

ANTRASİT renkli mekanizmalar

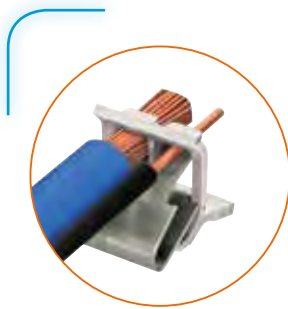

Bağlantı ucunun iki bağımsız yayı, 2,5 mm<sup>2</sup> kesite kadar değişik çaplarda kablolar için mükemmel bir kavrama sağlar.

► CAGE CLamba®S sistemi GmbH, Almanya firmasının **WAGO** ticari markasıdır!

**WAGO**  
INNOVATIVE CONNECTIONS

## Bağlantı şemaları

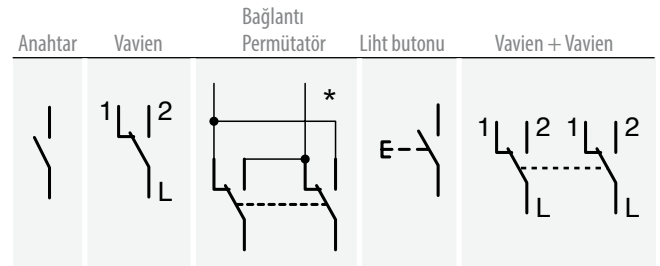

\* İşlevsel şema için eşdeğer sembol (bu sembol standart değildir ve 2 adet vavien ile eşleştirilerek yeniden oluşturulmuştur).

## SEÇİM TABLOSU

**KLASİK ANAHTAR**

Vidalı bağlantı

1 modül    2 modül    2 modül

**BEYAZ**

**ALÜMİNYUM**

**ANTRASİT**

Tanım

<b>Anahtar</b>	<input type="checkbox"/>	<b>HD4051</b>	<b>HD4051M2</b>
16A250V a.c.	<input type="checkbox"/>	<b>HC4051</b>	<b>HC4051/2</b>
	<input type="checkbox"/>	<b>HS4051</b>	<b>HS4051/2</b>
<b>Vavien</b>	<input type="checkbox"/>	<b>HD4053</b>	<b>HD4053M2</b>
16A250V a.c.	<input type="checkbox"/>	<b>HC4053</b>	<b>HC4053/2</b>
	<input type="checkbox"/>	<b>HS4053</b>	<b>HS4053/2</b>
<b>Permütatör</b>	<input type="checkbox"/>	<b>HD4054</b>	<b>HD4054M2</b>
16A250V a.c.	<input type="checkbox"/>	<b>HC4054</b>	<b>HC4054/2</b>
	<input type="checkbox"/>	<b>HS4054</b>	<b>HS4054/2</b>
<b>Liht butonu</b>	<input type="checkbox"/>	<b>HD4055</b>	<b>HD4055M2</b>
(NO) 10A 250V a.c.	<input type="checkbox"/>	<b>HC4055</b>	<b>HC4055/2</b>
	<input type="checkbox"/>	<b>HS4055</b>	<b>HS4055/2</b>
<b>2 x 2 Vavien</b>	<input type="checkbox"/>		<b>HD4024</b>
16A 250V a.c.	<input type="checkbox"/>		<b>HC4024</b>
	<input type="checkbox"/>		<b>HS4024</b>
<b>Anahtar</b>	<input type="checkbox"/>	<b>HD4051A20</b>	
20A 250V a.c.	<input type="checkbox"/>	<b>HC4051/20</b>	
	<input type="checkbox"/>	<b>HS4051/20</b>	
<b>Vavien</b>	<input type="checkbox"/>	<b>HD4053A20</b>	
1P 20A 250V a.c.	<input type="checkbox"/>	<b>HC4053/20</b>	
	<input type="checkbox"/>	<b>HS4053/20</b>	

BS EN 60 669-1 Standardına uygundur

 BEYAZ renkli mekanizmalar     ALÜMİNYUM renkli mekanizmalar     ANTRASİT renkli mekanizmalar

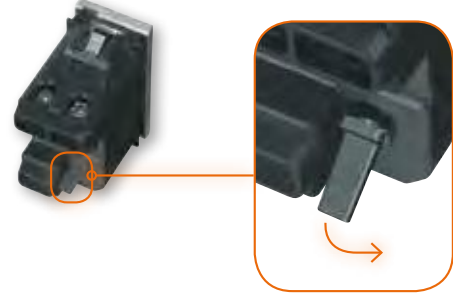
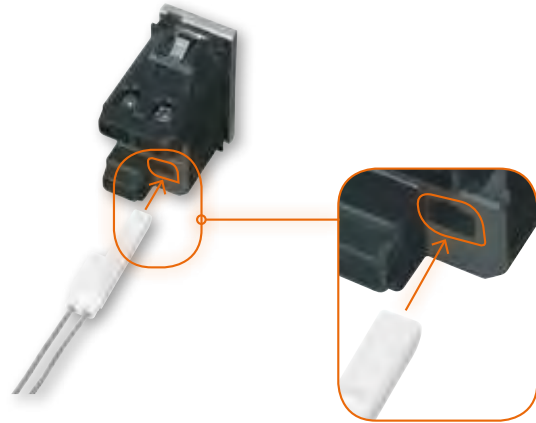
**LED REF. H4743B/230 MEKANİZMANIN ARKASINA YERLEŞTİRİLİR**
**1** LED ampülü takmadan önce plastik dili çıkarın ve mekanizmayı kaideye yerleştirin.

**2** LED ampülü yerleştirin

# TEMEL KONTROL MEKANİZMALARI

## BEYAZ



HD4045

## ALÜMİNYUM



HC4045

## ANTRASİT



HS4045

## ELEKTRONİK LIHT BUTONU

Referans Tanım

**HD4045** Liht butonu hassas dokunuş (NA) 1A  
**HC4045** 250V a.c. -dahili led  
**HS4045**

Bu hassas dokunuşlu liht butonları impuls rölelerin kontrolü için kullanılırlar. Referans numaraları: HD4331V230-HC-HS4331/230 ve HD4232V230-HC-HS4232/230'dur. HD/HC/HS4401 referanslı ürün ile birlikte kullanılarak, dimmerlerin uzaktan kontrolüne imkan tanır. BS EN 60 669-1 standardına uygundur.

## Impuls Röle bağlantı şeması: farklı noktalardan lamba kontrolü

### 3 kablolu bağlantı

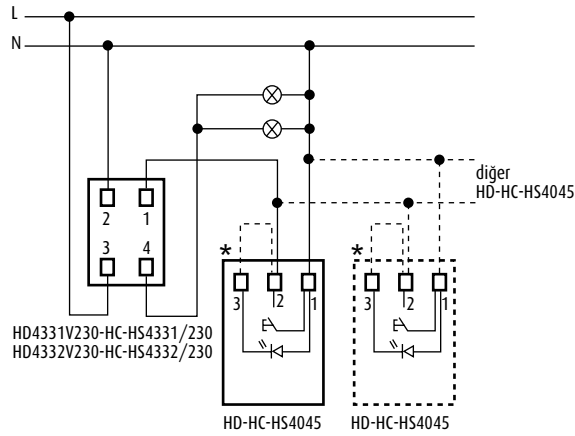

### 4 kablolu bağlantı

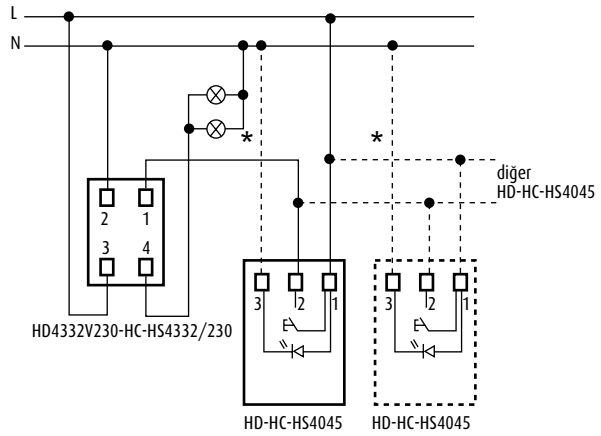

\* Dahili LED kontrolü

## Dimmer bağlantı şeması

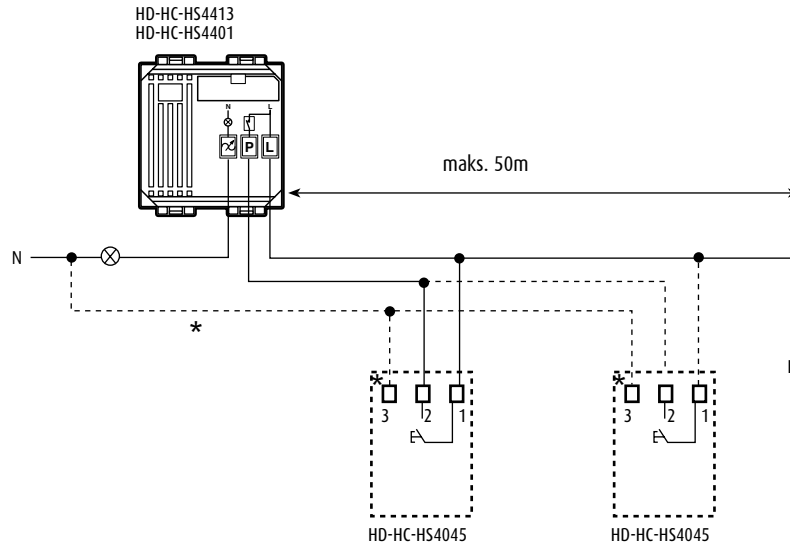

\* Dahili LED kontrolü



**BEYAZ**
**ALÜMİNYUM**
**ANTRASİT**

HD4044



HD4033



HC4044



HC4033



HS4044



HS4033



HD4034



HD4034M2



HC4034



HC4034/2



HS4034



HS4034/2



HD4036



HD4036M2



HC4036



HC4036/2



HS4036



HS4036/2



HD4037



HD4037M2



HC4037



HC4037/2



HS4037



HS4037/2



HD4042



HD4042M2



HC4042



HC4042/2



HS4042



HS4042/2



HD4043



HD4043M2



HC4043



HC4043/2



HS4043



HS4043/2



HD4055P



HD4055B



HC4055P



HC4055B



HS4055P



HS4055B

**LIHT BUTONLARI 10A**

Referans	Tanım
<b>HD4044</b> <b>HC4044</b> <b>HS4044</b>	Style liht butonu – basmalı acil durum butonu için bağımsız kontaklar 2 kutup (NO) 10A – 250V a.c.
<b>HD4033</b> <b>HC4033</b> <b>HS4033</b>	Kordonlu liht (ipli imdat) butonu (NA) 10A - 250V a.c.
<b>HD4034</b> <b>HC4034</b> <b>HS4034</b>	Değiştirilebilir tuş kapaklı Axial liht butonu 2 kutup (NC) 10A – 250V a.c.
<b>HD4034M2</b> <b>HC4034/2</b> <b>HS4034/2</b>	Değiştirilebilir tuş kapaklı Axial liht butonu, 2 modül 2 kutup (NC) 10A – 250V a.c.
<b>HD4036</b> <b>HC4036</b> <b>HS4036</b>	Çift tuşlu liht butonu 1 kutup (NO) + 1 kutup (NO) 10A – 250V a.c.
<b>HD4036M2</b> <b>HC4036/2</b> <b>HS4036/2</b>	Çift tuşlu liht butonu, 2 modül 1 kutup (NO) + 1 kutup (NO) 10A - 250V a.c.
<b>HD4037</b> <b>HC4037</b> <b>HS4037</b>	Çift tuşlu, ara kilitli, liht jaluzi anahtar 2 modül, 1 kutup (NO) + 1 kutup (NO) 10A - 250V a.c.
<b>HD4037M2</b> <b>HC4037/2</b> <b>HS4037/2</b>	Çift tuşlu, ara kilitli, liht jaluzi anahtar 2 modül, 1 kutup (NO) + 1 kutup (NO) 10A - 250V a.c.

BS EN 60 669-1 standardına uygundur

**SEMBOLLÜ AXIAL LIHT BUTONLARI**

Referans	Tanım
<b>HD4042</b> <b>HC4042</b> <b>HS4042</b>	Zil sembollü liht butonu 1 kutup (NO) 10A – 250V a.c.
<b>HD4042M2</b> <b>HC4042/2</b> <b>HS4042/2</b>	Zil sembollü liht butonu, 2 modül 1 kutup (NO) 10A – 250V a.c.
<b>HD4043</b> <b>HC4043</b>	Lamba sembollü liht butonu 1 kutup (NO) 10A – 250V a.c.
<b>HD4043M2</b> <b>HC4043/2</b> <b>HS4043/2</b>	Lamba sembollü liht butonu, 2 modül 1 kutup (NO) 10A – 250V a.c.

**KLASİK LIHT BUTON - SEMBOLLÜ**

Referans	Tanım
<b>HD4055P</b> <b>HC4055P</b> <b>HS4055P</b>	Liht butonu 1P (NO) 10AX - 250V a.c. sembollü
<b>HD4055B</b> <b>HC4055B</b> <b>HS4055B</b>	Liht butonu 1P (NO) 10AX - 250V a.c. Zil sembollü

# TEMEL KONTROL MEKANİZMALARI

## BEYAZ



HD4002



HD4011

## ALÜMİNYUM



HC4002



HC4011

## ANTRASİT



HS4002



HS4011

## 2 KUTUP ANAHTAR

Referans	Tanım
<b>HD4002</b> <b>HC4002</b> <b>HS4002</b>	2 kutup anahtar 16AX - 250V a.c.
<b>HD4011</b> <b>HC4011</b> <b>HS4011</b>	2 kutup anahtar 32A - 250V a.c.



HD4012  
HD4022



HC4012  
HC4022



HS4012  
HS4022

## 2 KUTUP ANAHTAR

Referans	Tanım
<b>HD4012</b> <b>HC4012</b> <b>HS4012</b>	A2 kutup kilitli anahtar. Kilit anahtarı hem ON hem de OFF konumunda çıkarılabilir – kilit anahtarları her cihaz için farklıdır. 16A 250Va.c.
<b>HD4022</b> <b>HC4022</b> <b>HS4022</b>	1 kutup kilitli Vavien - 16AX 250V a.c.
<b>HD4012C*</b> <b>HC4012C*</b> <b>HS4012C*</b>	1 kutup kilitli Vavien 16AX 250V a.c.
<b>HD4022C*</b> <b>HC4022C*</b> <b>HS4022C*</b>	1 kutup kilitli Vavien 16AX 250V a.c.

\* Her armatürün anahtar kilidi diğerlerinden farklıdır. Benzer kilitli armatürler almak için lütfen Bticino satış teknisyenlerine başvurunuz.

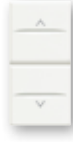

HD4027

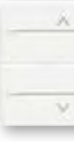

HD4027M2



HC4027



HC4027/2



HS4027



HS4027/2



HD4028H



HC4028H



HS4028H

## ENVERSÖR ANAHTARLAR 16A

Referans	Tanım
<b>HD4027</b> <b>HC4027</b> <b>HS4027</b>	İki tuşlu kalıcı jaluzili anahtarı (mekanik) 1-0-2 1 kutup 16A – 250V a.c.
<b>HD4027M2</b> <b>HC4027/2</b> <b>HS4027/2</b>	İki tuşlu kalıcı jaluzili anahtarı (mekanik) 1-0-2 - 2 modül
<b>HD4028H</b> <b>HC4028H</b> <b>HS4028H</b>	Oteller için iki tuşlu 1-0-2 anahtar Oda durumunu gösterir; "please do not disturb" ve "please clean the room". H4372V230H referanslı mekanizmayı ışıklandırmak için kullanılır.

BS EN 60 669-1 standardına uygundur.

## ORTAK ÜRÜNLER



H4372V230H



H4040

## OTEL ÇAĞRI IŞIKLAR

Referans	Tanım
<b>H4372V230H</b>	Kırmızı ve yeşil lamba tutucu "do not disturb/make up the room" - dahili led

## LIHT BUTONU İSİMLİKLİ

Referans	Tanım
<b>H4040</b>	1P (NO) 10A 250V - ışıklı, etiket plakalı liht butonu

BS EN 60 669-1 standardına uygundur.

**BEYAZ**
**ALÜMİNYUM**
**ANTRASİT**

HD4016



HC4016



HS4016

**HIZLI KONTROL ANAHTARI**

Referans	Tanım
<b>HD4016</b>	4 kademeli klima ve fan kontrol anahtarı. 3A 250V a.c.
<b>HC4016</b>	
<b>HS4016</b>	



HD4391



HC4391



HS4391

**JACK KONNEKTÖRÜ**

Referans	Tanım
<b>HD4391</b>	Ön-ayarlayıcı, 2 kontaklı jack - 48V 10A (ref 2124N)
<b>HC4391</b>	
<b>HS4391</b>	
<b>2124N</b>	HD-HC-HS4391 Jack için anahtar

**ORTAK ÜRÜNLER**

2124N

**BEYAZ**
**ALÜMİNYUM**
**ANTRASİT**

HD4544



HC4544



HS4544

**ENERGY SAVER**

Referans	Tanım
<b>HD4544</b>	Monoblok energy saver. Gecikmesiz Yük: 10A (akkor lambalar) - 3A (floresan lambalar) - dikdörtgen ve kare buatlarla kullanılır. 11250 lamba ile ışıklandırılabilir.
<b>HC4544</b>	
<b>HS4544</b>	
<b>L4546</b>	Energy saver için kart

**ORTAK ÜRÜNLER**

L4546

# TEMEL KONTROL MEKANİZMALARI

## BEYAZ



HD4038R12  
HD4038R24  
HD4038R230

## ALÜMİNYUM



HD4038V12  
HD4038V24  
HD4038V230

## ANTRASİT



HC4038R/12  
HC4038R/24  
HC4038R/230



HC4038V/12  
HC4038V/24  
HC4038V/230



HS4038R/12  
HS4038R/24  
HS4038R/230



HS4038V/12  
HS4038V/24  
HS4038V/230



HD4038LA12  
HD4038LA24  
HD4038LA230



HC4038LA/12  
HC4038LA/24  
HC4038LA/230



HS4038LA/12  
HS4038LA/24  
HS4038LA/230

## DEĞİŞTİRİLEBİLİR SEMBOLLÜ İŞIKLI LIHT BUTONU HD4038LA...-HC-HS4038LA/...

### Mavi semboller



H4920LA



H4920LB



H4920LC



H4920LD



H4920LE



H4920LF



H4920LG



H4920LH



H4920LL



H4920LM



H4920LN



H4920LP



H4920LQ



H4920LR



H4920LZ

### Beyaz semboller



H4920BLA



H4920BLB



H4920BLC



H4920BLD



H4920BLE



H4920BLF



H4920BLG



H4920BLH



H4920BLL



H4920BLM



H4920BLN



H4920BLP



H4920BLQ



H4920BLR



H4920BLZ

## GÖSTERGELİ AXİAL LIHT BUTONLARI

Referans	Kontak	Gösterge rengi	Voltaj seviyesi	Akım seviyesi
HD4038R12 HC4038R/12 HS4038R/12	1K (NO)	Kırmızı	12V a.c.	10A
HD4038R24 HC4038R/24 HS4038R/24	1K (NO)	Kırmızı	24V a.c.	10A
HD4038R230 HC4038R/230 HS4038R/230	1K (NO)	Kırmızı	230V a.c.	10A
HD4038V12 HC4038V/12 HS4038V/12	1K (NO)	Yeşil	12V a.c.	10A
HD4038V24 HC4038V/24 HS4038V/24	1K (NO)	Yeşil	24V a.c.	10A
HD4038V230 HC4038V/230 HS4038V/230	1K (NO)	Yeşil	230V a.c.	10A

NOT: BS EN 60 669-1 standardına uygundur.

## SEMBOLLÜ AXİAL LIHT BUTONLAR

### Lamba sembolü

Referans	Kontak	Gösterge rengi	Voltaj seviyesi	Akım şiddeti
HD4038LA12 HC4038LA/12 HS4038LA/12	1P (NO)	lamba sembolü mavi	12V a.c.	10A
HD4038LA24 HC4038LA/24 HS4038LA/24	1P (NO)	lamba sembolü mavi	24V a.c.	10A
HD4038LA230 HC4038LA/230 HS4038LA/230	1P (NO)	lamba sembolü mavi	230V a.c.	127V a.c.

NOT: BS EN 60 669-1 standardına uygundur.

## TUŞ KAPAKLARI

İşıklıdır, sembolü değiştirilebilir  
HD-HC-HS4038LA... tuş kapakları

Beyaz	Mavi	Tanım
H4920BLA	H4920LA	lamba
H4920BLB	H4920LB	merdiven boşluğu lambası
H4920BLC	H4920LC	masa ışığı
H4920BLD	H4920LD	zil
H4920BLE	H4920LE	fan
H4920BLF	H4920LF	kilit
H4920BLG	H4920LG	müzik
H4920BLH	H4920LH	telefon
H4920BLL	H4920LL	alarm
H4920BLM	H4920LM	ON (açık)
H4920BLN	H4920LN	OFF (kapalı)
H4920BLP	H4920LP	kurye
H4920BLQ	H4920LQ	hemşire
H4920BLR	H4920LR	servis
H4920BLS	H4920LS	PRESS
H4920BLZ	H4920LZ	baskızsız

Değiştirilemez buton



Değiştirilemez Liht butonu

**İŞIK SEMBOLLÜ AXİAL LIHT BUTONU:**  
farklı sembolü liht butonları elde etmek için katalogdaki tuş kapakları ile değiştirilebilir.  
Tuş kapaklarını değiştirmek için tornavida kullanınız.

HD4038LA...  
HC4038LA/...  
HS4038LA/...



değiştirilebilir



H4920..



# RÖLELER

**BEYAZ**

HD4331V230 HD4332V230

**ALÜMİNYUM**

HC4331/230 HC4332/230

**ANTRASİT**



HS4331/230 HS4332/230

**ELEKTRONİK RÖLE**

Referans Tanım

**HD4331V230** Implus röle, 10AX 250V a.c.  
**HC4331/230** – 3 kablolu  
**HS4331/230**
**HD4332V230** Implus röle, 10AX 250V a.c.  
**HC4332/230** – 3/4 kablolu  
**HS4332/230**
**NOT:** AX = Florasan ve akkor lambalar için akım şiddeti.  
 AXIAL anahtar ile önerilir.  
 BS EN 60 669-2-2 standardına uygundur

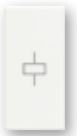
HD4330V230



HD4330V24



HD4330V12



HC4330/230



HC4330/24



HC4330/12



HS4330/230



HS4330/24



HS4330/12

**RÖLE**

Referans Tanım

**HD4330V230** NA/NK kontaklı röle 250V a.c. 10A  
**HC4330/230** (rezistif) 4A 230V bobin gerilimi  
**HS4330/230** 230V a.c.

**HD4330V24** bobin gerilimi 24V a.c.  
**HC4330/24**  
**HS4330/24**
**HD4330V12** bobin gerilimi 12V a.c.  
**HC4330/12**  
**HS4330/12**
**IMPLUS RÖLE: ELEKTRİKSEL BAĞLANTI**

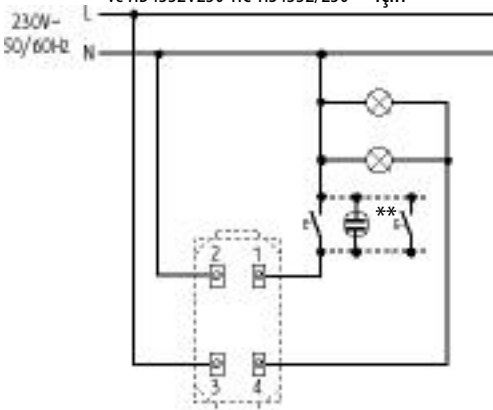
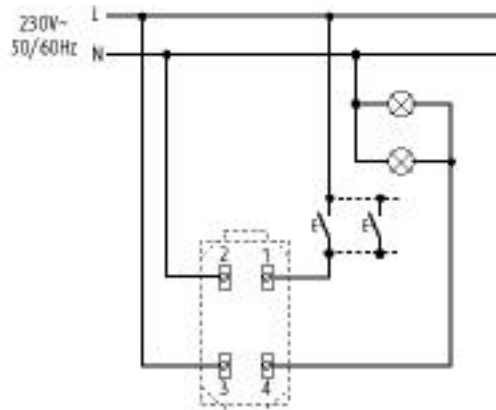
 3 kablolu bağlantı:  
 HD4331V230-HC-HS4331/230  
 ve HD4332V230-HC-HS4332/230\*\* için

 4 kablolu bağlantı:  
 HD4332V230-HC-HS4332/230 için

\*\* HD4332V230-HC-HS4332/230 için ampul yerleştirilmez.

# İŞIKLANDIRILABİLİR SEMBOLLÜ TUŞ KAPAKLARI

## BEYAZ



HD4921LA HD4921M2LA



HD4921LB HD4921LC



HD4921LD HD4921LE HD4921LF



HD4921LG HD4921LH HD4921LL



HD4921LM HD4921LN HD4921LP

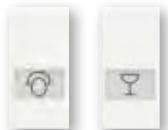

HD4921LQ HD4921LR

## ALÜMİNYUM



HC4921LA HC4921/2LA



HC4921LB HC4921LC



HC4921LD HC4921LE HC4921LF



HC4921LG HC4921LH HC4921LL



HC4921LM HC4921LN HC4921LP



HC4921LQ HC4921LR

## ANTRASİT



HS4921LA HS4921/2LA



HS4921LB HS4921LC



HS4921LD HS4921LE HS4921LF



HS4921LG HS4921LH HS4921LL



HS4921LM HS4921LN HS4921LP



HS4921LQ HS4921LR

## İŞIKLANDIRILABİLİR SEMBOLLÜ TUŞ KAPAKLARI - AXİAL ANAHTARLAR İÇİN

Tanım	1 modül	2 modül
lamba	HD4921LA HC4921LA HS4921LA	HD4921M2LA HC4921/2LA HS4921/2LA
merdiven boşluğu lambası	HD4921LB HC4921LB HS4921LB	HD4921M2LB HC4921/2LB HS4921/2LB
masa ışığı	HD4921LC HC4921LC HS4921LC	HD4921M2LC HC4921/2LC HS4921/2LC
zil	HD4921LD HC4921LD HS4921LD	HD4921M2LD HC4921/2LD HS4921/2LD
fan	HD4921LE HC4921LE HS4921LE	HD4921M2LE HC4921/2LE HS4921/2LE
kilit	HD4921LF HC4921LF HS4921LF	HD4921M2LF HC4921/2LF HS4921/2LF
müzik	HD4921LG HC4921LG HS4921LG	HD4921M2LG HC4921/2LG HS4921/2LG
telefon	HD4921LH HC4921LH HS4921LH	HD4921M2LH HC4921/2LH HS4921/2LH
alarm	HD4921LL HC4921LL HS4921LL	HD4921M2LL HC4921/2LL HS4921/2LL
ON	HD4921LM HC4921LM HS4921LM	HD4921M2LM HC4921/2LM HS4921/2LM
OFF	HD4921LN HC4921LN HS4921LN	HD4921M2LN HC4921/2LN HS4921/2LN
kurye	HD4921LP HC4921LP HS4921LP	HD4921M2LP HC4921/2LP HS4921/2LP
hemşire	HD4921LQ HC4921LQ HS4921LQ	HD4921M2LQ HC4921/2LQ HS4921/2LQ
servis	HD4921LR HC4921LR HS4921LR	HD4921M2LR HC4921/2LR HS4921/2LR

**NOT:** Axial anahtarlar HD-HC-HS4001 - HD-HC-HS4003 - HD-HC-HS4004 - HD-HC-HS4005 - HD4001M2-HC-HS4001/2 - HD4003M2-HC-HS4003/2 - HD4004M2-HC-HS4004/2 - HD4005M2-HC-HS4005/2 ve otomatik bağlantılı anahtarlar

**Mekanizmanın kendi tuş kapağını tornavida yardımı ile çıkararak sembollü tuş kapağı ile değiştirebilirsiniz.**



Değiştirilebilir tuş kapağı

değiştirilebilir

HD4001 - HC4001 - HS4001  
HD4003 - HC4003 - HS4003  
HD4004 - HC4004 - HS4004  
HD4005 - HC4005 - HS4005  
ve otomatik bağlantılı anahtarlar

HD4001M2 - HC4001/2 - HS4001/2  
HD4003M2 - HC4003/2 - HS4003/2  
HD4004M2 - HC4004/2 - HS4004/2  
HD4005M2 - HC4005/2 - HS4005/2

HD4921.. HD4921M2..  
HC4921.. HC4921/2..  
HS4921.. HS4921/2..

# DİMMERLER

## BEYAZ



HD4401 HD4402



HD4407 HD4413  
HD4582



HD4416

## ALÜMİNYUM



HC4401 HC4402



HC4407 HC4413  
HC4582



HC4416

## ANTRASİT



HS4401 HS4402



HS4407 HS4413  
HS4582



HS4416

## DİMMER

Referans	Tanım
<b>HD4401</b> <b>HC4401</b> <b>HS4401</b>	Çevirmeli (rotatif) dimmer – TRIAC/IGBT- SOFT START VE SOFT-STOP fonksiyonu ile göz kamaştırmayı engeller, kendinden sigortalı – 2 modül
<b>HD4402</b> <b>HC4402</b> <b>HS4402</b>	Çevirmeli (rotatif) dimmer – TRIAC/IGBT- SOFT START VE SOFT-STOP fonksiyonu ile göz kamaştırmayı engeller, kendinden sigortalı – 1 modül
<b>HD4407</b> <b>HC4407</b> <b>HS4407</b>	Dokunmatik (rotatif) dimmer – TRIAC/IGBT- SOFT START VE SOFT-STOP fonksiyonu ile göz kamaştırmayı engeller, kendinden sigortalı – 2 modül
<b>HD4413</b> <b>HC4413</b> <b>HS4413</b>	Dokunmatik (rotatif) dimmer – TRIAC/IGBT- SOFT START VE SOFT-STOP fonksiyonu ile göz kamaştırmayı engeller, kendinden sigortalı – 2 modül
<b>HD4416</b> <b>HC4416</b> <b>HS4416</b>	HC/HS4413 tarafından kontrol edilebilen "yardımcı" dimmer. TRIAC/IGBT-SOFT START VE SOFT-STOP fonksiyonu ile göz kamaştırmayı engeller, kendinden sigortalı – 2 modül
<b>HD4582</b> <b>HC4582</b> <b>HS4582</b>	dokunmatik 230V a.c./110-127V a.c.

**NOT:** Aşağıda yer alan tabloya bakarak seçim yapınız. BS EN 60 669-2-1 standardına uygundur.

## ORTAK ÜRÜNLER



L4405/60 - L4405/105

## ELEKTRONİK TRANSFORMATÖRLER

Halojen lambalar için

Referans	Tanım
<b>L4405/60</b>	düşük gerilimli kvartz - iodiene lambalar için elektronik transformatörler - 230V a.c. – 50Hz – 12V çıkış – kontrol edilebilir güç 20W-60W
<b>L4405/105</b>	kontrol edilebilir güç 35W-105W

BS EN 61047 standardına uygundur.

## DİMMERLER İÇİN SEÇİM TABLOSU

Yük tipi	Güç	Gerilim	Frekans	Referans
Rezistif - ferromanyetik transformatörler için	60 - 500 W	230V a.c. ± 10%	50/60Hz	<b>HD-HC-HS4401</b>
Rezistif	60 - 500 W	230V a.c.	50Hz	<b>HD-HC-HS4402</b>
Elektronik transformatörler için	60 - 250 VA	230V a.c..	50Hz	<b>HD-HC-HS4407</b>
Rezistif - ferromanyetik transformatörler için	60 - 500 W	230V a.c.	50Hz	<b>HD-HC-HS4413, HD-HC-HS4416</b>
	60 - 500 VA			
	50 - 1000 W / 50 - 500W	230V a.c./110-127V a.c.	50/60Hz	<b>HD-HC-HS4582</b>
	50 - 500 VA / 50 - 300 VA			

# SICAKLIK KONTROL

## BEYAZ



HD4451

## ALÜMİNYUM



HC4451

## ANTRASİT



HS4451

## KRONOTERMOSTAT

Referans Tanım

- HD4451** Isıtma ve iklimlendirme sistemleri için günlük/haftalık programlanabilir  
**HC4451** kronotermostat - aydınlatmalı ekran -  
**HS4451** besleme 2x1.5V pil - harici sensör kullanarak tele aktivasyon imkanı - 1A çıkış - 3 modül

BS EN 60 730 standardına uygundur



HD4441  
HD4442



HC4441  
HC4442



HS4441  
HS4442

## ODA TERMOSTATI

Referans Tanım

- HD4441** elektronik ortam termostati.  
**HC4441** 2A 250V a.c. 250V a.c. tek çıkışlı röleli -  
**HS4441**  
**HD4442** "yaz/kış" seçimli elektronik ortam  
**HC4442** termostati. C-NO 2A 250V a.c.  
**HS4442** enversör kontaklı - 230V a.c.

BS EN 60 730 standardına uygundur



F462



3457

## AKSESUARLAR

Referans Tanım

- F462** GSM telefon aktüatörü - 4 DIN modül  
**3457** HD-HC-HS4451 için harici sensör



# ELEKTRONİK KONTROL MEKANİZMALARI

**BEYAZ**

HD4425

HD4426

**ALÜMİNYUM**

HC4425

HC4426

**ANTRASİT**

HS4425

HS4426

**RÖLELİ KIZIL ÖTESİ ALICILAR**

Referans

Tanım

**HD4425**
**HC4425**
**HS4425**

Röle çıkışlı 1 kanal alıcı uzaktan kumandalı anahtar. 6A cosφ 1 – 230 Vac – 2 modül

**HD4426**
**HC4426**
**HS4426**

Röle çıkışlı 2 kanal alıcı uzaktan kumandalı jaluzi butonu. 4A cosφ 1 – 230 Vac – 2 modül

BS EN 60 669-2-1 Standardına uygundur



HD4431



HD4432



HC4431



HC4432



HS4431



HS4432

**PASİF İNFRARED ANAHTARLAR**

Referans

Tanım

**HD4431**
**HC4431**
**HS4431**

Pasif IR hareket dedektörlü anahtar ayarlanabilen karanlık algılama devresi, istenirse hariç tutulabilir - gecikmeli kapatma devresi, 30 san ile 10 dk arasında ayarlanabilir - röle çıkışı 2A, rezistif/2A endüktif - besleme 230V a.c. - 1 modül

**HD4432**
**HC4432**
**HS4432**

Pasif IR hareket dedektörlü anahtar ayarlanabilen karanlık algılama devresi, istenirse hariç tutulabilir - gecikmeli kapatma devresi, 30 san ile 10 dk arasında ayarlanabilir, istenirse harici düğmeler ile kumanda edilebilir - röle çıkışı 6A, rezisif/2A endüktif - 0-A-1 selektörüyle - güç kaynağı 230V a.c. - 2 modül

BS EN 60 669-2-1 standardına uygundur

**ORTAK ÜRÜNLER**

3529

**UZAKTAN KUMANDA**

Referans

Tanım

**3529**

 Uzaktan kumanda alıcısı (aynı oda içinde 16 kanala kadar)  
- doğrudan seçilebilen 8 verici kanal, diğer 8 ise seçim anahtarlarıyla seçilebilen kanallar  
- 9V pil ile çalışır

# ELEKTRONİK KONTROL MEKANİZMALARI

## BEYAZ



HD4530M2



HD4530M3

## ALÜMİNYUM



HC4530/2



HC4530/3

## ANTRASİT



HS4530/2

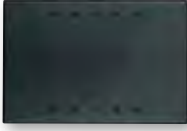

HS4530/3

## DOKUNMATİK ANAHTARLAR

Referans Tanım

**HD4530M2** Dokunmatik anahtar - 16A rezistif,  
**HC4530/2** 10A akkor lamba, 4A cosφ 0.5  
**HS4530/2** ferromanyetik transformatörler ve 4A  
floresan lambaları - 2 modül

**HD4530M3** Dokunmatik anahtar - 3 modül  
**HC4530/3**  
**HS4530/3**

# PRİZLER

## Alman ve Fransız standardı

**BEYAZ**

 HD4141  
HD4141W

**ALÜMİNYUM**

 HC4141  
HC4141W

**ANTRASİT**

 HS4141  
HS4141W

**ALMAN STANDARTI**

2 modül

Referans	Tanım
<b>HD4141</b> <b>HC4141</b> <b>HS4141</b>	2P+T 10/16A çocuk korumalı Schuko topraklı priz
<b>H4141R</b>	Kırmızı 2P+T 10/16A çocuk korumalı Schuko topraklı priz
<b>HD4141W</b> <b>HC4141W</b> <b>HS4141W</b>	2P+T 10/16A çocuk korumalı, otomatik bağlantılı Schuko topraklı priz
<b>HD4141PW</b> <b>HC4141PW</b> <b>HS4141PW</b>	Kapaklı topraklı priz 2P+T vidalı bağlantı
<b>H4141RW</b>	Kırmızı 2P+T 10/16A çocuk korumalı schuko topraklı priz, otomatik bağlantı



HD4142



HD4141PW



HC4142



HC4141PW

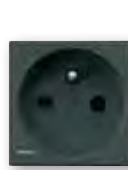

HS4142



HS4141PW

**ORTAK ÜRÜNLER**

 H4141R  
H4141RW

H4142R

**FRANSIZ STANDARTI PRİZLER**

2 modül

Referans	Tanım
<b>HD4142</b> <b>HC4142</b> <b>HS4142</b>	Fransız standardı - çocuk korumalı topraklı priz (UPS priz) 2 modül
<b>H4142R</b>	Fransız standardı - çocuk korumalı topraklı priz (UPS priz) 2 modül

**YENİ VİDASIZ BAĞLANTI UÇLARI, KAFES KLİPSLER: BAĞLANTI MÜKEMMELLİĞİ**

Sert ve esnek kablolar için yenilikçi otomatik bağlantı uçları. Kablolar üzerindeki sabit basınç uzun süreli en uygun teması sağlar: vidalı bağlantı uçlarında yaşanan yarım dönüş sorunu kesinlikle çözülmüştür.

- Basit ve çabuk kablo bağlantısı: sadece kabloyu sıyırın ve doğrudan bağlantı ucuna yerleştirin.
- İçi kablo dolu buatlarda, açıklık için bir tornavida kullanmak, kazara yerinden çıkmayı engeller.

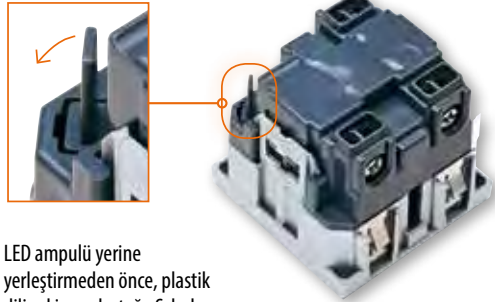

LED ampülü yerine yerleştirmeden önce, plastik dili çekin ve desteğe Schuko kontakları takın..



Bağlantı ucunun iki bağımsız yayı, 2,5 mm<sup>2</sup> kesite kadar değişik çaplarda kablolar için mükemmel bir kavrama sağlar. 2.5 mm<sup>2</sup>

**Sert kablolar ile bağlantı örneği**

1

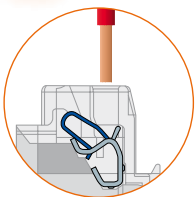

2

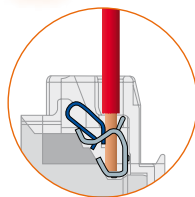

3

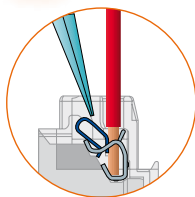

4

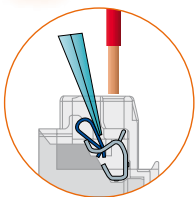

Kabloyu sıyırdıktan sonra doğrudan bağlantı ucuna takın

Kabloyu dışarı çekmek için bir tornavida kullanın

# PRİZLER

## Diğer prizler

### BEYAZ



HD4113

### ALÜMİNYUM



HC4113

### ANTRASİT



HS4113

### İTALYAN STANDARDI

1 modül

Referans Tanım

**HD4113** İtalyan standardı topraklı priz  
**HC4113** 2P+T 10A 250V a.c.  
**HS4113**



HD4177  
HD4177V127



HC4177  
HC4177/127



HS4177  
HS4177/127

### TIRAŞ PRİZİ

Referans Tanım

**HD4177** Transformatörlü tıraş makinası prizi  
**HC4177** - 230V a.c. 50/60Hz çıkış  
**HS4177** 115/230V a.c. 20VA - 3 modül

# TV, FM VE SAT PRİZLERİ

## BEYAZ



HD4202D



HD4202P



HD4202PT

## ALÜMİNYUM



HC4202D



HC4202P



HC4202PT

## ANTRASİT



HS4202D



HS4202P



HS4202PT

## EKRANLANMIŞ TV + SAT

Referans	Tanım
<b>HD4202D</b> <b>HC4202D</b> <b>HS4202D</b>	Yıldız bağlantılı TV prizi (sonlu) – erkek konnektör, 1modül
<b>HD4202P</b> <b>HC4202P</b> <b>HS4202P</b>	Geçişli TV prizi – erkek konnektör, 1modül
<b>HD4202PT</b> <b>HC4202PT</b> <b>HS4202PT</b>	Geçişli, 75 Ω empedans adaptör ile sonlandırılmış TV prizi – 1 modül



HD4202DC



HC4202DC



HS4202DC

## EKRANLANMIŞ TV

Referans	Tanım
<b>HD4202DC</b> <b>HC4202DC</b> <b>HS4202DC</b>	Sonlu TV prizi - erkek konnektör 1 modül



HD4269F



HC4269F



HS4269F

## F TİPİ VE TV PRİZİ

Referans	Tanım
<b>HD4269F</b> <b>HC4269F</b> <b>HS4269F</b>	"F" tipi koaksiyel TV prizi 75Ω empedanslı



HD4214D



HC4214D



HS4214D

## ÖZEL TV-SAT

Referans	Tanım
<b>HD4214D</b> <b>HC4214D</b> <b>HS4214D</b>	TV-SAT prizi 1 modül bağlantılı



HD4201D



HC4201D



HS4201D

## DIŞI TV PRİZİ

Referans	Tanım
<b>HD4201D</b> <b>HC4201D</b> <b>HS4201D</b>	Sonlu TV koaksiyel - Ø 9.5 mm



# TV, FM VE SAT PRİZLERİ

## BEYAZ



HD4210D

## ALÜMİNYUM



HC4210D

## ANTRASİT



HS4210D

## EKRANLANMIŞ TV + FM + SAT

Referans Tanım

<b>HD4210D</b>	Sonlu TV+FM+SAT prizi
<b>HC4210D</b>	
<b>HS4210D</b>	



HD4211D  
HD4213D



HC4211D  
HC4213D



HS4211D  
HS4213D

## EKRANLANMIŞ TV +FM

Referans Tanım

<b>HD4211D</b>	Sonlu TV-FM prizi - Ø 9,5mm
<b>HC4211D</b>	- 2 modül
<b>HS4211D</b>	



HD4212  
HD4204



HD4207



HC4212  
HC4204



HC4207



HS4212  
HS4204



HS4207

## TUŞ KAPAKLARI

Referans Tanım

<b>HD4204</b>	TV+FM prizi için tuş kapağı
<b>HC4204</b>	
<b>HS4204</b>	
<b>HD4207</b>	TV+FM+SAT prizi için tuş kapağı
<b>HC4207</b>	
<b>HS4207</b>	
<b>HD4212</b>	TV/FM+SAT prizi için tuş kapağı
<b>HC4212</b>	
<b>HS4212</b>	

## ORTAK ÜRÜNLER



S2133



75RTN

## FİŞ VE DİRENÇ

Referans Tanım

<b>S2133</b>	TV fişi ve jack - Ø 9,5 mm - Beyaz - TV + SAT jackları ve N/NT4206D da kullanılır.
<b>75RTN</b>	Geçişli bağlantılı TV prizi için, 75Ω empedanslı sonlandırma direnci - son geçişli TV prizine eklenir.

# DATA PRİZLERİ

**BEYAZ**

 HD4279C6A  
HD4279C6  
HD4279C6S

 HD4262C6  
HD4262C6S

**ALÜMİNYUM**

 HC4279C6A  
HC4279C6  
HC4279C6S

 HC4262C6  
HC4262C6S

**ANTRASİT**

 HS4279C6A  
HS4279C6  
HS4279C6S

 HS4262C6  
HS4262C6S

**RJ45 PRİZLER**

Referans	Priz tipi	Cat.	Sonlandırma tipi
<b>HD4279C6A</b> <b>HC4279C6A</b> <b>HS4279C6A</b>	RJ45	6A STP	aletsiz IDC
<b>HD4279C6</b> <b>HC4279C6</b> <b>HS4279C6</b>	RJ45	6 UTP	aletsiz IDC
<b>HD4279C6S</b> <b>HC4279C6S</b> <b>HS4279C6S</b>	RJ45	6 STP	aletsiz IDC
<b>HD4262C6</b> <b>HC4262C6</b> <b>HS4262C6</b>	RJ45	6 UTP	110 IDC
<b>HD4262C6S</b> <b>HC4262C6S</b> <b>HS4262C6S</b>	RJ45	6 STP	110 IDC



HD4258C11N



HD4258C11D



HC4258/11N



HC4258/11D



HS4258/11N



HS4258/11D

**PRİZLER RJ11 - RJ12**

Referans	Priz tipi	Cat.	Sonlandırma tipi
<b>HD4258C11N</b> <b>HC4258/11N</b> <b>HS4258/11N</b>	RJ11	3	K10
<b>HD4258C11D</b> <b>HC4258/11D</b> <b>HS4258/11D</b>	RJ11	3	K10

# AUDIO-VIDEO VE DİĞER PRİZLER

## BEYAZ



HD4280 HD4281 HD4294



HD4292 HD4282



HD4283

## ALÜMİNYUM



HC4280 HC4281 HC4294



HC4292 HC4282



HC4283

## ANTRASİT



HS4280 HS4281 HS4294



HS4292 HS4282



HS4283

## AUDIO-VIDEO PRİZLER

Referans	Tanım
<b>HD4280</b> <b>HC4280</b> <b>HS4280</b>	audio priz - jack 3.5
<b>HD4281</b> <b>HC4281</b> <b>HS4281</b>	audio priz - RCA x 2
<b>HD4294</b> <b>HC4294</b> <b>HS4294</b>	Home theatre sistemi için hoparlör konnektör
<b>HD4292</b> <b>HC4292</b> <b>HS4292</b>	5 kutup DIN hi-fi veya benzeri bağlantı için
<b>HD4282</b> <b>HC4282</b> <b>HS4282</b>	video priz - HD15
<b>HD4283</b> <b>HC4283</b> <b>HS4283</b>	RCA x 3



HD4291 HD4293



HC4291 HC4293



HS4291 HS4293



HD4284 HD4285



HC4284 HC4285



HS4284 HS4285

## DİĞER PRİZLER

Referans	Tanım
<b>HD4291</b> <b>HC4291</b> <b>HS4291</b>	2 kutuplu mini soket - giriş çapı Ø 3mm - 13mm aralıklı - harici ve benzer devreler için - 6A 24V SELV - bağlantısı 2120 fiş ile uyumludur.
<b>HD4293</b> <b>HC4293</b> <b>HS4293</b>	2 çift kutuplu DIN konnektör
<b>HD4284</b> <b>HC4284</b> <b>HS4284</b>	HDMI priz
<b>HD4285</b> <b>HC4285</b> <b>HS4285</b>	USB priz

# SESLİ VE IŞIKLI SİNYALİZASYON MEKANİZMALARI

**BEYAZ**
**ALÜMİNYUM**
**ANTRASİT**

 HD4351V12  
HD4351V230

HD4355V12

 HC4351/12  
HC4351/230

HC4355/12

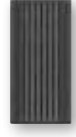
 HS4351/12  
HS4351/230

HS4355/12

**ZİLLER**

Referans Tanım

**HD4351V12** Mekanik zil 12V a.c. – 5VA – 80dB  
**HC4351/12**  
**HS4351/12**
**HD4351V230** Mekanik zil 230V a.c. – 12VA – 80dB  
**HC4351/230**  
**HS4351/230**
**HD4355V12** 3 melodi seçeneikli, ses ayarlı elektronik zil –  
**HC4355/12** 12V a.c. – d.c. – 2 modül  
**HS4355/12**

BS EN 62 080 standardına uygundur

 HD4356V12  
HD4356V230

 HC4356/12  
HC4356/230

 HS4356/12  
HS4356/230

**BAZERLER**

Referans Tanım

**HD4356V12** Bazer 12V a.c. – 5VA – 80dB  
**HC4356/12**  
**HS4356/12**
**HD4356V230** Bazer 230V a.c. – 12VA – 80dB  
**HC4356/230**  
**HS4356/230**

BS EN 62 080 standardına uygundur



HD4380



HC4380



HS4380

**SEYYAR EMNİYET LAMBASI**

Referans Tanım

**HD4380** Pili yerinden çıkarılıp seyyar hale gelebilen  
**HC4380** beyaz LED'li, – Ni-MH şarj edilebilen  
**HS4380** hafızasız asık batarya ile çalışabilen,  
 – 2 saat çalışma süreli emniyet  
 aydınlatma lambası. – beslenme 230V  
 a.c. – 2 modül  
**L4380/B** Emniyet lambası için batarya

BS EN 62 080 standardına uygundur

**ORTAK ÜRÜNLER**

L4380/B

 H4382/12  
 H4382/24  
 H4382/230

**MERDİVEN BASAMAĞI LAMBASI**

Referans Tanım

**H4382/12** Beyaz LED'li merdiven basamağı lambası  
 – 12V a.c.

**H4382/24** Beyaz LED'li merdiven basamağı lambası  
 – 24V a.c.

**H4382/230** Beyaz LED'li merdiven basamağı lambası  
 – 230V a.c. ve 127V a.c.

BS EN 62 094-1 standardına uygundur

# SESLİ VE IŞIKLI SİNYALİZASYON MEKANİZMALARI

## ORTAK ÜRÜNLER



H4371B/12  
H4371B/24  
H4371B/230



H4371T/12  
H4371T/24  
H4371T/230



H4371R/12  
H4371R/24  
H4371R/230



H4371V/12  
H4371V/24  
H4371V/230



H4372RT/12  
H4372RT/24  
H4372RT/230



H4372RV/12  
H4372RV/24  
H4372RV/230

## PİLOT LAMBALAR

Referans	Sayı	Lamba renkli	LED	Voltaj	Güç Kaynağı
H4371B/12	1	Mavi	12V a.c.	26mA	300mW
H4371B/24	1	Mavi	24V a.c.	27mA	700mW
H4371B/230	1	Mavi	127 ve 230V a.c.	21mA	500mW
H4371T/12	1	şeffaf	12V a.c.	26mA	300mW
H4371T/24	1	şeffaf	24V a.c.	27mA	700mW
H4371T/230	1	şeffaf	127 ve 230V a.c.	21mA	500mW
H4371R/12	1	Kırmızı	12V a.c.	26mA	300mW
H4371R/24	1	Kırmızı	24V a.c.	27mA	700mW
H4371R/230	1	Kırmızı	127 ve 230V a.c.	21mA	500mW
H4371V/12	1	Yeşil	12V a.c.	26mA	300mW
H4371V/24	1	Yeşil	24V a.c.	27mA	700mW
H4371V/230	1	Yeşil	127 ve 230V a.c.	21mA	500mW
H4372RT/12	2	Kırmızı + şeffaf	12V a.c.	26mA	300mW
H4372RT/24	2	Kırmızı + şeffaf	24V a.c.	27mA	700mW
H4372RT/230	2	Kırmızı + şeffaf	127 ve 230V a.c.	21mA	500mW
H4372RV/12	2	Kırmızı + Yeşil	12V a.c.	26mA	300mW
H4372RV/24	2	Kırmızı + Yeşil	24V a.c.	27mA	700mW
H4372RV/230	2	Kırmızı + Yeşil	127 ve 230V a.c.	21mA	500mW

BS EN 62 094-1 standardına uygundur

## ACİL AYDINLATMALAR

Referans	Tanım
H4384X1	Enerji kesilmesi durumunda otomatik devreye giren ışıklı acil aydınlatma - liht butonu ile manuel devre dışı bırakılabilir - Ni-Cd bataryalarla şarj edilir - 1 saat çalışma rezervi 230 Vac besleme, 60 Hz - 1W lamba - 4 modül - 50 ve Hz
H4384X3	3 saat çalışma rezervsiz
H4386X1	1 saat çalışma rezervli - 1.3 W - 6 modül
H4386X3	3 saat çalışma rezervsiz
H4386X1L	daimi aydınlatma - 24 saat aydınlatma gerektiren odalar için 1 saat çalışma rezervli
H4386X3L	3 saat çalışma rezervli



H4384X1  
H4384X3



H4386X1  
H4386X3  
H4386X1L  
H4386X3L

## SPARE BATTERY

Referans	Tanım
L4784/1	ref. H4384X1 için batarya
L4784/3	ref. H4384X3 için batarya
L4786/1	ref. H4386X1 ve H4386X1L için batarya
L4786/3	ref. H4386X3 ve H4386X3L için batarya



L4784/1



L4784/3  
L4786/1  
L4786/3



# ELEKTRİKSEL GÜVENLİK MEKANİZMALARI

**BEYAZ**
**ALÜMİNYUM**
**ANTRASİT**

HD4301A6  
HD4301A10  
HD4301A16



HC4301/6  
HC4301/10  
HC4301/16



HS4301/6  
HS4301/10  
HS4301/16

**DEVRE KESİCİLER**

Otomatik termik manyetik devre kesiciler.

Referans Tanım

**HD4301A6** 1P+N termik manyetik devre kesici 6A -  
**HC4301/6** kesme kapasitesi 1500A  
**HS4301/6**

**HD4301A10** 1P+N termik manyetik devre kesici 10A -  
**HC4301/10** kesme kapasitesi 3000A  
**HS4301/10**

**HD4301A16** 1P+N termik manyetik devre kesici 16A -  
**HC4301/16** kesme kapasitesi 3000A  
**HS4301/16**

BS EN 60 898 standardına uygundur



HD4305A6  
HD4305A10  
HD4305A16



HC4305/6  
HC4305/10  
HC4305/16



HS4305/6  
HS4305/10  
HS4305/16

**KAÇAK AKIM KORUMA ANAHTARLARI**

Otomatik, termik manyetik devre kesici akım koruma anahtarları

Referans Tanım

**HD4305A6** 1P+N, IΔn 10mA -  
**HC4305/6** - 6A, test butonlu kaçak akım koruma  
**HS4305/6** anahtarı - kesme kapasitesi 1500A -  
2 modül

**HD4305A10** 1P+N, IΔn 10mA - 10A, test butonlu  
**HC4305/10** kaçak akım koruma anahtarı - kesme  
**HS4305/10** kapasitesi 3000A, 2 modül

**HD4305A16** 1P+N, IΔn 10mA - 16A, test butonlu  
**HC4305/16** kaçak akım koruma anahtarı -  
**HS4305/16** kesme kapasitesi 3000A, 2 modül

**KARTUŞ SİGORTA**

Referans Tanım

**HD4321** 5x20 VE 6.3x32 kartuş sigorta için  
**HC4321** - maks. 10A 250Va.c.  
**HS4321**

**HD4322** T sigortalar için taşıyıcı  
**HC4322** - maks. 16A 250Va.c.  
**HS4322**



HD4321



HD4322



HC4321



HC4322



HS4321



HS4322

**PARAFUDR**

Referans Tanım

**HD4536** Priz ile kombine edilebilir parafudr.  
**HC4536** Maks. akım I<sub>max</sub>=2kA,  
**HS4536** - maks. koruma gerilimi U<sub>p</sub>=1kV  
- anma gerilimi U<sub>c</sub>. 100-230Va.c.



HD4536



HC4536



HS4536

# GAZ DEDEKTÖRLERİ

## BEYAZ



HD4511V12

HD4512V12

## ALÜMİNYUM

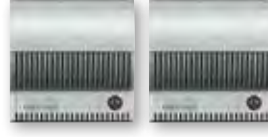

HC4511/12

HC4512/12

## ANTRASİT



HS4511/12

HS4512/12

## GAZ DEDEKTÖRLERİ

Referans	Tanım
<b>HD4511V12</b>	Görsel ve sesli alarmlı (85dB) metan gazı dedektörü - 2 modül - 12Va.c./d.c.
<b>HC4511/12</b>	
<b>HS4511/12</b>	
<b>HD4512V12</b>	Görsel ve sesli alarmlı (85dB) LPG dedektörü - 2 modül - 12Va.c./d.c.
<b>HC4512/12</b>	
<b>HS4512/12</b>	



HD4520



HC4520



HS4520

## SİNYAL TEKRARLAYICI

Referans	Tanım
<b>HD4520</b>	Gaz dedektörleri görsel ve sesli (85 dB)
<b>HC4520</b>	- alarm tekrarlayıcı - 2 modül
<b>HS4520</b>	



HD4541



HC4541



HS4541

## TRANSFORMATÖR

Referans	Tanım
<b>HD4541</b>	Gaz dedektörleri için transformatör
<b>HC4541</b>	230Va.c. 12Va.c.
<b>HS4541</b>	- 4VA - 2 modül

## ORTAK ÜRÜNLER



F91/12E

## DIN TRANSFORMATÖRÜ

Referans	Tanım
<b>F91/12E</b>	Gaz dedektörleri için DIN rayına monte edilebilen transformatör 230Va.c. - 12Va.c. - 6VA - 3 modül



L4525/12NO

## SELENOID VALF

Referans	Tanım
<b>L4525/12NO</b>	NA gaz selenoid valf - manual ayarlı - güç kaynağı 12V 50Hz - güç 3VA - çalışmadığı zamanki tüketimi: 0 - maks. basınç 500 mbar - IP65 koruma - derecesi çalışma ısısı -15+60°C - 3/4 inç dişli tapalar ve 1/2 inç redüksiyon ile birlikte

**NOT:** HC/HS4541 ve F91/12E güç kaynağı ile kullanılması tavsiye edilir

# İŞIKLI KAİDELER

## ORTAK ÜRÜNLER



HA4702X



HB4702X



HA4703X



HB4703X



HA4704X



HB4704X

**NOT:** HA4703... - HB4703... - HA4704... - HB4704...  
yalnızca 503E, PB503, 504E, PB504 butonlarına  
uygundur

## İŞIKLI KAİDELER

Referans	Tanım
<b>HA4702X</b>	2 mod. dikdörtgen çerçeveler için ışıklı kaide – 230V a.c. – 2.5mA – 0.3W
<b>HB4702X</b>	2 mod. eliptik çerçeveler için ışıklı kaide– 230V a.c. – 2.5mA – 0.3W
<b>HA4703X</b>	3 mod. dikdörtgen çerçeveler için ışıklı kaide – 230V a.c. – 2.5mA – 0.3W
<b>HB4703X</b>	3 mod. eliptik çerçeveler için ışıklı kaide – 230V a.c. – – 2.5mA – 0.3W
<b>HA4704X</b>	4 mod. dikdörtgen çerçeveler için ışıklı kaide – 230V a.c. – 2.5mA – 0.3W
<b>HB4704X</b>	4 mod. eliptik çerçeveler için ışıklı kaide – 230V a.c. – 2.5mA – 0.3W

BS EN 62094-1 standardına uygundur. İki kaide yan yana yerleştirilemez

### İşıklı kaide kullanımı hakkında notlar

- mekanizmanın ışıklı kaide üzerine montaj şekli, standart kaidede olduğu gibidir
- mekanizmanın ve kaidenin kablo bağlantıları yapılır



- sıva altı buata yerleştirilir
- çerçeve yerleştirilir

### İşıklandırılmış mekanizma ve kaide

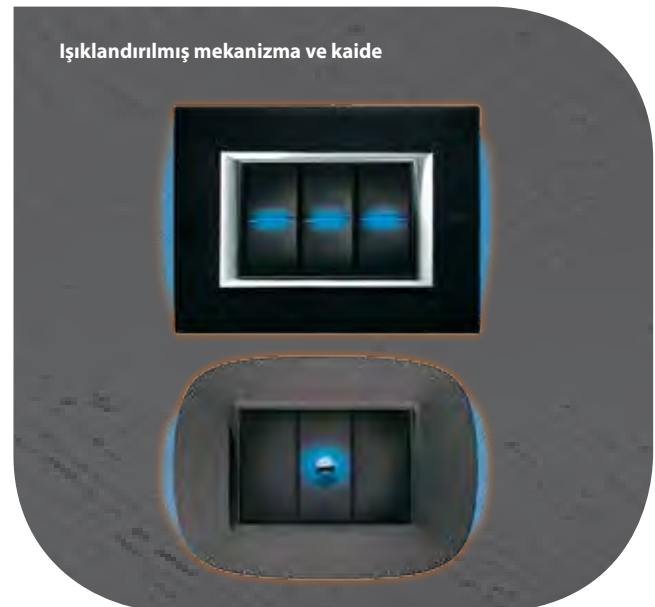

# BOŞLUK KAPAKLARI

## BEYAZ



HD4949 HD4950



HD4951



HD4953 HD4954

## ALÜMİNYUM



HC4949 HC4950



HC4951



HC4953 HC4954

## ANTRASİT



HS4949 HS4950



HS4951



HS4953 HS4954

## BOŞLUK KAPAKLARI

Referans	Tanım
<b>HD4949</b> <b>HC4949</b> <b>HS4949</b>	1/2 modül boşluk kapağı
<b>HD4950</b> <b>HC4950</b> <b>HS4950</b>	1 modül boşluk kapağı
<b>HD4951</b> <b>HC4951</b> <b>HS4951</b>	2 modül boşluk kapağı
<b>HD4953</b> <b>HC4953</b> <b>HS4953</b>	9 mm delikli çaplı boşluk kapağı - 1 modül
<b>HD4954</b> <b>HC4954</b> <b>HS4954</b>	9 mm delikli çaplı boşluk kapağı - 2 modül

# AKSESUARLAR VE AMPULLER

## ORTAK ÜRÜNLER



503CG



503EV



503DE



503ED

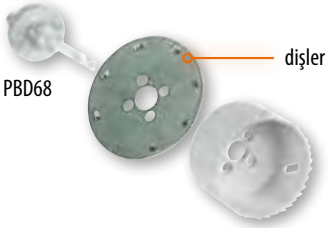

PBD68

dişler

## LED AMPULLER



H4743B/230



11255

11256

## LED AMPULLER

Referans Tanım

**H4743B/230** Mavi LED ampül – 230V a.c. - 2.5mA - 0.3W

**11256** HD-HC-HS4183 için LED lamba

## SIVA ALTI BUAT AKSESUARLARI

Referans Tanım

**503CG** 503E ref. siva altı buat için koruma kapağı alçılama işlemi sonlandırmak için kullanılabilir.

**503EV** bölücü - malzeme : resim - 503E ref. buatlar için yeni tasarım

**503DE** bölücü - malzeme : resim - 504E ref. buatlar için

**503ED** 503E - 504E - 506E - 506L referanslı buatlar için dikey ve yatay bölücüler

## DELİKLİ FREZE BIÇAĞI İÇİN AKSESUAR

Referans Tanım

**PBD68** alçıpan buatların montajı için disk tipi bıçak

## REFERANS H4743B/230'UN KULLANILABİLECEĞİ MEKANİZMALAR

Anahtarlar	Vavienler	Permütatörler	Liht butonlar	Vidalı bağlantı prizler	Otomatik bağlantı prizler
HD4001 - HD4001M2	HD4003 - HD4003M2	HD4004 - HD4004M2	HD4005 - HD4005M2	HD4140	HD4140W
HC4001 - HC4001/2	HC4003 - HC4003/2	HC4004 - HC4004/2	HC4005 - HC4005/2	HC4140	HC4140W
HS4001 - HS4001/2	HS4003 - HS4003/2	HS4004 - HS4004/2	HS4005 - HS4005/2	HS4140	HS4140W
HZ4001 - HZ4001M2	HZ4003 - HZ4003M2	HZ4004 - HZ4004M2	HZ4005 - HZ4005M2	HD4140A16	HD4140A16W
HX4001 - HX4001/2	HX4003 - HX4003/2	HX4004 - HX4004/2	HX4005 - HX4005/2	HC4140/16	HC4140/16W
HY4001 - HY4001/2	HY4003 - HY4003/2	HY4004 - HY4004/2	HY4005 - HY4005/2	HS4140/16	HS4140/16W
HD4051 - HD4051M2	HD4053 - HD4053M2	HD4054 - HD4054M2	HD4055 - HD4055M2	HD4141	HD4141W
HC4051 - HC4051/2	HC4053 - HC4053/2	HC4054 - HC4054/2	HC4055 - HC4055/2	HC4141	HC4141W
HS4051 - HS4051/2	HS4053 - HS4053/2	HS4054 - HS4054/2	HS4055 - HS4055/2	HS4141	HS4141W
HD4001W - HD4001M2W	HD4003W - HD4003M2W		HD4005W - HD4005M2W	H4140R	H4140RW
HC4001W - HC4001/2W	HC4003W - HC4003/2W		HC4005W - HC4005/2W	H4140R	H4140RW
HS4001W - HS4001/2W	HS4003W - HS4003/2W		HS4005W - HS4005/2W	H4140/16R	H4140/16RW
HZ4001W - HZ4001M2W	HZ4003W - HZ4003M2W		HZ4005W - HZ4005M2W	H4141R	HD4141PW
HX4001W - HX4001/2W	HX4003W - HX4003/2W		HX4005W - HX4005/2W	H4141R	HC4141PW
HY4001W - HY4001/2W	HY4003W - HY4003/2W		HY4005W - HY4005/2W	HD4142	HS4141PW
				HC4142	H4141RW
				HS4142	
				H4142R	

**NOT:** LED eklenmesi ile ilgili detaylar için önceki sayfalara bakınız.





## İÇİNDEKİLER

## AXOLUTE MY HOME

Kontrol .....	80
Kablolu otomasyon .....	84
Kablosuz otomasyon .....	94
HI-FI stereo müzik yayın sistemi .....	98
Hırsız alarm .....	105
Sıcaklık kontrol .....	115
Enerji yönetimi .....	118
Ortak aksesuarlar .....	119



# MY HOME

## Kontrol



HD4690



HC4690

### DOKUNMATİK EKCRAN

Referans Tanım

- HD4690** 10" 16/9 LCD multimedya dokunmatik ekran:
- HC4690** - MY HOME sistem kontrol
- HS4690** - İnterkom sistemi fonksiyonları
- Video görüntüleme sistemleri
- RSS bilgi
- USB SD kart girişleri
- Hırsız alarm



HS4690

### DOKUNMATİK EKCRAN ÇERÇEVESİ

Referans Tanım

- HA4690XC** Alüminyum çerçeve
- HA4690VBB** Beyaz çerçeve
- HA4690LTK** Tik ağacı çerçeve
- HA4690VNB** Nighter çerçeve
- HA4690VSW** Whice çerçeve

### ÇERÇEVELER



HA4690VBB



HA4690VSW



HA4690XC



HA4690VNB



HA4690LTK

### Dokunmatik ekran montajı



Multimedya  
Dokunmatik ekran

Çerçeve

Çerçeve sabitleyici



H4687

### VİDEO DOKUNMATİK PANEL

Referans Tanım

**H4687** sıva altı PC panel, 15" dokunmatik monitör F215/24 S buata monte edilir. WEB SERVER ile beraber kullanılır.



H4684

### RENKLİ DOKUNMATİK PANEL

Referans Tanım

**H4684** Aydınlatma, panjur kontrol, müzik yayın sistemi, iklimlendirme, hırsız alarm gibi, My Home sisteminin tüm fonksiyonlarının kontrol ve kumanda edilebildiği, senaryolar içinde arayüz fonksiyonu taşıyan renkli dokunmatik panel



3465

### MULTİMEDYA ARAYÜZ

Referans Tanım

**3465** Bütün MY HOME sistemi uygulamaları ve multimedia içeriğinin herhangi bir televizyon veya (PAL) monitor veya Nighter ve Whice video ünitiden kontrolünü sağlar.

BEYAZ

ALÜMİNYUM

ANTRASİT



349418



349414



349415

### MULTİMEDYA ARAYÜZ PRİZLERİ

Referans Tanım

**349418**  
**349414**  
**349415** 3465 arayüzün 8 kontaklı BUS prizi

# MY HOME

## Kontrol

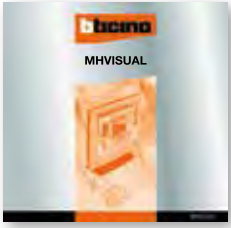

MHVISUAL

### MHVISUAL YAZILIMI

Referans Tanım

**MHVISUAL** MHVISUAL yazılımı MY HOME sistemin görsel olarak kontrol edilmesini sağlar.



F420

### SENARYO MODÜLÜ

Referans Tanım

**F420** 16 senaryoya kadar otomasyon, müzik yayın sistemi, sıcaklık sistemi ve interkom uygulamalarından oluşan senaryolar kaydedebilir - 2 DIN modül



MH200N



346020

### SENARYO PROGRAMLAYICI

Referans Tanım

**MH200N** TIMH200 programıyla yaratılan senaryoların aktive edilmesi için kullanılır. Senaryolar, zamanla, tarihle, manuel olarak, sıcaklık kontrol sistemiyle ve hırsız alarm sistemiyle ilişkilendirilebilir 6 DIN modülü

### MH200N İÇİN GÜÇ KAYNAĞI

Referans Tanım

**346020** MH200N senaryo programlayıcı için kompakt güç kaynağı 2 DIN





F453AV



F453



346020

#### WEB SERVER AUDIO/VIDEO

Referans	Tanım
<b>F453AV</b>	Audio/video WEB SERVER
<b>F453</b>	SCS sistemi izlemek ve kontrol etmek için WEB SERVER
<b>346020</b>	F453AV ve F453 için kompakt güç kaynağı, 2 DIN modül



F422

#### SCS-SCS ARAYÜZ

Referans	Tanım
<b>F422</b>	SCS BUS sistemleri için arayüz - 2 DIN arayüz



F426



F427

#### FARKLI SİSTEMLER İÇİN ARAYÜZLER

Referans	Tanım
<b>F426</b>	SCS/EIB arayüz EIB sistemi MY HOME sistemini kontrol için
<b>F427</b>	SCS/KNX arayüz - MY HOME sistemi ve KNX haberleşmesi için



F429

#### SCS/DALI ARAYÜZ

Referans	Tanım
<b>F429</b>	DALI protokolü ile çalışan cihazların BUS SCS sistemi ile kontrol edilmesi için arayüz.

# MY HOME

## Kablolu otomasyon



H4651M2

### ÖZEL ANAHTAR

Referans Tanım

**H4651M2** özel fonksiyonlu anahtar aktuatörün bütün standart kontrollerine ek olarak birçok farklı şekilde kontrolünü sağlar: senaryo aktivasyonu, farklı bus'ta yer alan aktuatör kontrolü, soft-start & soft-stop dimmer kontrolü vb. Tek ya da 2 tuş kapağı ile tamamlanabilir.



H4652/2



H4652/3

### TEK YA DA BİRDEN FAZLA YÜKÜN KONTROLÜ

Referans Tanım

**H4652/2** tek ya da çift yük için bir aktuatörü yada, tek yada bağımsız çift yük için iki ayrı aktuatörü kontrol eder. Tek modül iki ayrı tuş kapağı yada iki modüllü tek bir tuş kapağı ile bir yada iki fonksiyonu kontrol eder

**H4652/3** tek yada bağımsız çift yük için üç ayrı aktuatörü kontrol eder. Tek modüllü üç ayrı tuş kapağı ile bir yada iki fonksiyonu kontrol eder

**NOT:** alt kapaklar ürünle birlikte temin edilir

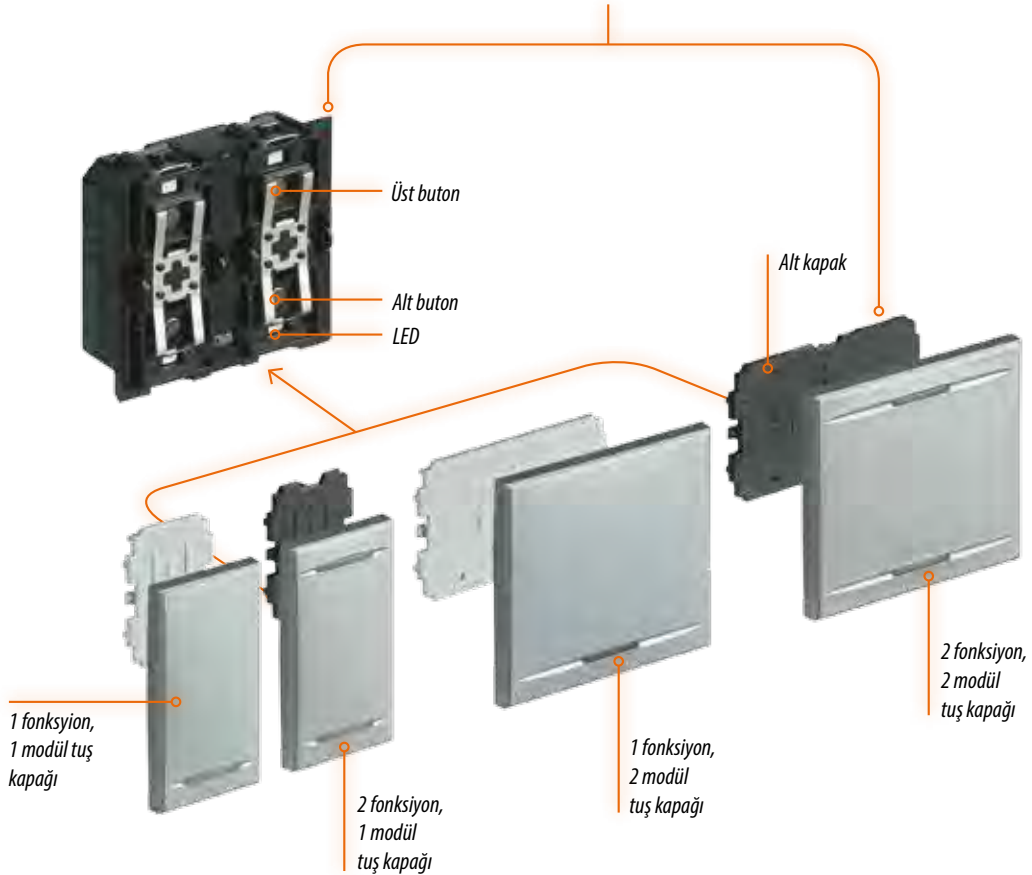

**BEYAZ**

HD4653M2

**ALÜMİNYUM**

HC4653/2

**ANTRASİT**

HS4653/2



HD4653M3



HC4653/3



HS4653/3

**SOFT TOUCH ANAHTARLAR**

Referans

Tanım

**HD4653M2** F420 ye kaydedilmiş senaryoyu yada bir aktüatörü aktive edebilen  
**HC4653/2** veya ayarlayabilen 2 mod LED yoğunluğu ayarlanabilen soft  
**HS4653/2** touch kontrol anahtarı

**HD4653M3** yukarıdaki gibi 3 modül  
**HC4653/3**  
**HS4653/3**

**BEYAZ CAM**

HD4657M3



HD4657M4

**WHICE**

HC4657M3



HC4657M4

**NIGHTER**

HS4657M3



HS4657M4

**DİJİTAL CAM ANAHTARLAR**

Tekil yükler veya yük grupları (aydınlatma ve jaluzi), müzik yayın sistemi, temel interkom fonksiyonları (kapı açma) kontrolü için kullanılır.

Konfigürasyon iki farklı yoldan yapılır:

fiziksel (konfigüratörlerin yuvalarına takılması suretiyle veya sanal olarak. Aydınlık düzeyi ayarlanabilir LED ler ile donatılmıştır.

Referans

Tanım

**BEYAZ CAM**

**HD4657M3** 6 tuş - 3 modül

**HD4657M4** 8 tuş - 4 modül

**WHICE**

**HC4657M3** 6 tuş - 3 modül

**HC4657M4** 8 tuş - 4 modül

**NIGHTER**

**HS4657M3** 6 tuş - 3 modül

**HS4657M4** 8 tuş - 4 modül

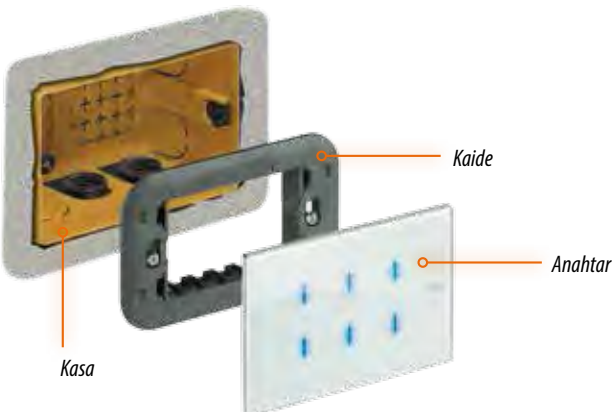
**Dijital cam anahtar kurulumu**

Kasa	Kaide	Anahtar
<b>503E</b>	<b>H4703</b>	<b>HD4657M3</b>
		<b>HC4657M3</b>
		<b>HS4657M3</b>
<b>504E</b>	<b>H4704</b>	<b>HD4657M4</b>
		<b>HC4657M4</b>
		<b>HS4657M4</b>

# MY HOME

## Kablolu otomasyon

### BEYAZ



HD4685

### ALÜMİNYUM

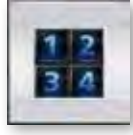

HC4685

### ANTRASİT

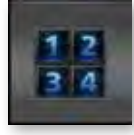

HS4685



HD4563



HC4563



HS4563



HD4680



HC4680



HS4680



HD4607



HC4607



HS4607



HD4607Z4



HC4607/4



HS4607/4

### ORTAK ÜRÜNLER



3530S



3540

### LOCAL DISPLAY

Referans Tanım

**HD4685** OLED teknoloji ile üretilen dokunmatik ekran ile otomasyon,  
**HC4685** sıcaklık kontrol ve müzik yayın sistemini kontrol etmek  
**HS4685** mümkündür

### ROTATİF KONTROL

Referans Tanım

**HD4563** Dimmer kontrolü  
**HC4563** (seviye 1 - 99%, soft-start vs.).  
**HS4563**

### SENARYO KONTROL

Referans Tanım

**HD4680** F420 senaryo modülünde kaydedilmiş 4 farklı senaryoyu  
**HC4680** kontrol etmek için kullanılır  
**HS4680**

### ŞİFRELI KONTROLLER

Referans Tanım

**HD4607** şifreli kontrolleri aktive eder. 30'a kadar transponder kaydedebilir  
**HC4607** - 2 modül  
**HS4607**

**HD4607Z4** şifreli kontrolleri aktive eder. 30'a kadar transponder kaydedebilir.  
**HC4607/4** 4 senaryoyu transponder ile aktive eder  
**HS4607/4** - 2 modül

### TRANSPONDER

Referans Tanım

**3530S** taşınabilir transponder kart - transponder okuyucuya yaklaştırıldığında  
aktivasyon için gerekli sinyali BUS üzerinde oluşturur - pil gerektirmez -  
otomatik olarak transponder okuyucu ile şifrelenir.

**3540** yukarıdaki gibi transponder halka

**BEYAZ**
**ALÜMİNYUM**
**ANTRASİT**

HD4654



HC4654



HS4654

**ORTAK ÜRÜNLER**

3529

**BEYAZ**
**ALÜMİNYUM**
**ANTRASİT**

HD4610



HC4610



HS4610



HD4611



HC4611



HS4611

**ORTAK ÜRÜNLER**

 N4640  
N4640B

**KIZIL ÖTESİ ALICI**

Referans Tanım

<b>HD4654</b>	3529 referanslı uzaktan kumanda ile kullanılan IR alıcısı. F420
<b>HC4654</b>	senaryo modülüne yüklenmiş olan 16 senaryoyu da
<b>HS4654</b>	kontrol edilebilir

**UZAKTAN KUMANDA**

Referans Tanım

<b>3529</b>	IR uzaktan kumanda - 16 iletişim kanalı doğrudan seçilebilir - 2x1.5V AAA pil ile birlikte
-------------	--

**IR DEDEKTÖRLER**

Referans Tanım

<b>HD4610</b>	Kızılötesi hacimsel hareket dedektörü – hafızalı LED alarm sinyali
<b>HC4610</b>	14 kanallı – yardımcı ön-alarm kanalı devreye sokulabilir
<b>HS4610</b>	– 8 metre kapasiteli, dikey ve yatay 0° - 105°, 3 kademeye bölünmüş
<b>HD4611</b>	Yukarıdaki gibi hacimsel varlık dedektörü – dikey ve yatay 0°
<b>HC4611</b>	- 105°, – 2 aks üzerinde oynayabilen lens
<b>HS4611</b>	

**PIR MİNİ-DEDEKTÖR**

Referans Tanım

<b>N4640</b>	105° algılama açılı, 8 metre kapasiteli mini IR hareket dedektörü – hafızalı LED li alarm sinyali – Yardımcı kanal aktive edilebilir - belli bir açıyla eğik olarak duvara monte edilir
<b>N4640B</b>	yukarıdaki gibi - kapasite 6 metre

**İŞIK/HAREKET SENSÖRÜ**

Referans Tanım

<b>BMSE1001</b>	PIR BUS sensor hareket ve ışık yoğunluğunu algılamak için. Tavana montaj, IP20, vidalı bağlantı, 6 m (28 m <sup>2</sup> ) alanı 2,5 m yükseklikte kapsar. Maksimum 4 m yükseklikte montaj yapılabilir. 27 V 10 mA tüketim. Fiziksel veya sanal konfigürasyon
-----------------	--



BMSE1001



# MY HOME

## Kablolu otomasyon



H4671/1



H4671/2



H4678

### SIVA ALTI DİMMER VE AKTUATÖRLER

Referans	Tanım
<b>H4671/1</b>	bir röleli aktuatör- maks. 6A resistif yada akkor lambaları, 2A cosφ 0.5 ferromanyetik transformatörleri ve 150W floresan lambaları kontrol edebilir. İki modül tek bir tuş kapağı ile bir ya da iki fonksiyonu yerine getirir
<b>H4671/2</b>	iki röleli 500W a kadar motor aktuatörü- 2 fonksiyon için 2 modül tuş kapağı ile tamamlanır
<b>H4678</b>	akkor lambalar ve ferromanyetik transformatörler için dimmer aktuatör. – 60 VA dan 300VA ya 230V a.c. İki modül tek bir tuş kapağı ile bir ya da iki fonksiyonu yerine getirir



3475



3476

### TEMEL AKTUATÖRLER

Referans	Tanım
<b>3475</b>	Bir röleli aktuatör - tek yük için: 2A resistif yada 2A cosφ 0.5 ferromanyetik transformatörleri kontrol edebilir. Kontrol cihazının arkasına siva altı montaj kutusuna monte edilebilir
<b>3476</b>	Bir röleli aktuatör - tek yük için: 2A resistif yada 2A 0.5 cosφ ferromanyetik transformatörleri kontrol edebilir. N/A kontaklı bir liht butonu ile kumanda edilir



F411/1N



F411/2



F411/4



F411/1NC



F411/2NC

### MODÜLLER AKTUATÖRLER

Referans	Tanım
<b>F411/1N</b>	Tek kontaklı (NO veya NK) röle: 16A resistif, 10A akkor lambalar, 4A cosφ 0.5 ferromanyetik transformatörler ve 4A floresan lambalar için
<b>F411/2</b>	2 bağımsız röleli aktuatör. Tek ve çift yükler için, 10A resistif ya da 6A akkor lambaları, 500W motorları, 2A cosφ 0.5 ferromanyetik transformatörleri ve 250W floresan lambaları kontrol edebilir. Cihaz konfigüratörler ile ayarlanır
<b>F411/4</b>	4 bağımsız röleli aktuatör. Tek, çift yada kombine yükler için, 6A resistif, 2A akkor lambaları, 500W motorları, 2A cosφ 0.5 ferromanyetik transformatörleri ve 70W floresan lambaları kontrol edebilir. Cihaz konfigüratörler ile ayarlanır
<b>F411/1NC</b>	Tek kontaklı (1 NC) röle: 16A resistif, 10A akkor lambalar ve 4A floresan lambalar. ON konumunda cihazın kontağı kapalı konumdadır ve OFF (kapama) komutu yollandığında kontağını açar. Böylece BUS hattı enerjisizken de cihaz ON konumunda kalarak yükün aktif kalmasını sağlayacaktır.
<b>F411/2NC</b>	2 bağımsız (NK) röleli 6A resistif ve akkor lambalar ve 0.65A floresan lambalar. ON konumunda cihazın kontakları kapalı konumdadır ve OFF (kapama) komutu yollandığında kontaklarını açar. Böylece BUS hattı enerjisizken de cihaz ON konumunda kalarak yük/yüklerin aktif kalmasını sağlayacaktır.
<b>BMSW1001</b>	1 çıkışlı ON/OFF aktuatör: Maksimum yük 16A RJ 45 bağlantı, IP20, 230V besleme - 4DIN modül
<b>BMSW1002</b>	2 bağımsız çıkışlı ON/OFF aktuatör: Her çıkış için maksimum yük 16A, RJ 45 bağlantı, IP20, 230V besleme - 4DIN modül
<b>BMSW1003</b>	4 bağımsız çıkışlı ON/OFF aktuatör: Her çıkış için maksimum yük 16A, RJ45 bağlantı, IP20, 230V besleme - 6 DIN modül



BMSW1001



BMSW1002



BMSW1003



F413N



BMDI1001



F414



F415



F46U1



F417U2



F429

**MODÜLER DİMMERLER**

Referans	Tanım
<b>F413N</b>	Tek çıkışlı dimmer : 1-10 V giriş sinyali ile floresan veya LED lambalarının kontrolü, 230Vac'da 2.5A - vidalı bağlantı - 27 Vdc besleme - 30 mA tüketim. Maksimum 10 balasta kadar - 2 DIN modül
<b>BMDI1001</b>	Tek çıkışlı dimmer : 1-10V kontrolü 230Vac'de 4.3A - RJ 45 bağlantı. IP20 - 230Vac besleme - 6 DIN modül
<b>F414</b>	Tek çıkışlı dimmer: Akkor lambalar ve ferromanyetik transformatörlü halojen lambalar için, 230Vac'de 1000W - 27 Vdc besleme - 9mA tüketim 4 DIN modül
<b>F415</b>	Tek çıkışlı dimmer : Elektronik transformatörlü halojen lambalar. 230Vac'de 400VA - 27Vdc besleme - 22 mA tüketim - 4 DIN modül
<b>F416U1</b>	Tek çıkışlı dimmer: Bütün yükler, 230Vac'de 4.3A, RJ 45 bağlantı IP20, 230 VAC besleme, 6 DIN modül
<b>F417U2</b>	İki çıkışlı dimmer: Bütün yükler, 230Vac'de 1.7A - RJ 45 bağlantı. IP20 - 230Vac besleme, 6 DIN modül
<b>F429</b>	DALI Dimmer: 8 çıkışlı - herbir çıkışa 16 DALI balastı bağlanabilir. 230Vac besleme - tüketim 5mA - 6 DIN modül

# MY HOME

## Kablolu otomasyon



3477



F428

### KONTAK ARAYÜZÜ

Referans	Tanım
<b>3477</b>	Kontak arayüzüyle 2 aktuatörü tek - fonksiyon kontrolü veya 1 aktuatörü iki-fonksiyon kontrolüyle kumanda etmek için bağımsız 2 kuru kontakta sahiptir
<b>F428</b>	yukarıdaki gibi - 2 DIN modül



F425

### HAFIZA MODÜLÜ

Referans	Tanım
<b>F425</b>	Aktuatör durumlarını kaydederek - elektrik kesintisinden sonra sistemi son konumuna getirmek için kullanılır - 2 DIN modül

# MY HOME

## Kablolu otomasyon - Serigrafik baskılı tuş kapakları - 1 fonksiyon

**BEYAZ**
**ALÜMİNYUM**
**ANTRASİT**

HD4915AA



HC4915AA



HS4915AA



HD4915M2AA



HC4915/2AA



HS4915/2AA

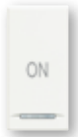

HD4915AB

 HD4915M2AB  
HD4915M2AC

HC4915AB



HC4915AC



HS4915AB



HS4915AC



HD4915AD

 HD4915M2AD  
HD4915M2BA

HC4915AD



HC4915BA



HS4915AD



HS4915BA



HD4915BB

 HD4915M2BB  
HD4915M2BC

HC4915BB



HC4915BC



HS4915BB



HS4915BC

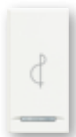

HD4915BD

 HD4915M2BD  
HD4915M2BE

HC4915BD



HC4915BE



HS4915BD



HS4915BE



HD4915BF

 HD4915M2BF  
HD4915M2BG

HC4915BF



HC4915BG



HS4915BF



HS4915BG



HD4915BH



HD4915M2BH



HC4915BH



HC4915/2BH



HS4915BH



HS4915/2BH

**1-FONKSİYON TUŞ KAPAKLARI**

Serigrafik baskılı

Referans

Sembol

1 modül

2 modül

HD4915AA

HD4915M2AA

OFF

HC4915AA

HC4915/2AA

HS4915AA

HS4915/2AA

HD4915AB

HD4915M2AB

ON

HC4915AB

HC4915/2AB

HS4915AB

HS4915/2AB

HD4915AC

HD4915M2AC

GEN

HC4915AC

HC4915/2AC

HS4915AC

HS4915/2AC

HD4915AD

HD4915M2AD

dimmer

HC4915AD

HC4915/2AD

HS4915AD

HS4915/2AD

HD4915BA

HD4915M2BA

ışık

HC4915BA

HC4915/2BA

HS4915BA

HS4915/2BA

HD4915BB

HD4915M2BB

zil

HC4915BB

HC4915/2BB

HS4915BB

HS4915/2BB

HD4915BC

HD4915M2BC

fan

HC4915BC

HC4915/2BC

HS4915BC

HS4915/2BC

HD4915BD

HD4915M2BD

kilit

HC4915BD

HC4915/2BD

HS4915BD

HS4915/2BD

HD4915BE

HD4915M2BE

sol anahtarı

HC4915BE

HC4915/2BE

HS4915BE

HS4915/2BE

HD4915BF

HD4915M2BF

hemşire

HC4915BF

HC4915/2BF

HS4915BF

HS4915/2BF

HD4915BG

HD4915M2BG

oda

HC4915BG

HC4915/2BG

HS4915BG

HS4915/2BG

HD4915BH

HD4915M2BH

ALARM

HC4915BH

HC4915/2BH

HS4915BH

HS4915/2BH

# MY HOME

## Kablolu otomasyon

### Serigrafik tuş kapakları - 2 fonksiyon

#### BEYAZ



HD4911AF



HD4911M2AF



HD4911AG

HD4911M2AG



HD4911AH

HD4911M2AH



HD4911BC

HD4911M2BC



HD4911BE

HD4911M2BE

#### ALÜMİNYUM



HC4911AF



HC4911M2AF



HC4911AG

HC4911M2AG



HC4911AH

HC4911M2AH



HC4911BC

HC4911M2BC



HC4911BE

HC4911M2BE

#### ANTRASİT



HS4911AF



HS4911M2AF



HS4911AG

HS4911M2AG



HS4911AH

HS4911M2AH



HS4911BC

HS4911M2BC



HS4911BE

HS4911M2BE

#### 2-FONKSİYON TUŞ KAPAKLARI

Serigrafik baskılı

Referans

Symbol

1 modül

2 modül

HD4911AF

HD4911M2AF

ON – OFF – GEN

HC4911AF

HC4911/2AF

HS4911AF

HS4911/2AF

HD4911AG

HD4911M2AG

ON – OFF

HC4911AG

HC4911/2AG

HS4911AG

HS4911/2AG

HD4911AH

HD4911M2AH

YUKARI-AŞAĞI

HC4911AH

HC4911/2AH

HS4911AH

HS4911/2AH

HD4911AI

HD4911M2AI

ON – OFF ayarlı

HC4911AI

HC4911/2AI

HS4911AI

HS4911/2AI

HD4911BA

HD4911M2BA

ışık

HC4911BA

HC4911/2BA

HS4911BA

HS4911/2BA

HD4911BC

HD4911M2BC

fan

HC4911BC

HC4911/2BC

HS4911BC

HS4911/2BC

HD4911BE

HD4911M2BE

sol anahtarı

HC4911BE

HC4911/2BE

HS4911BE

HS4911/2BE



## MY HOME

### Kablolu otomasyon - Baskısız tuş kapakları - 1 ve 2 fonksiyon

**BEYAZ****ALÜMİNYUM****ANTRASİT**

HD4911



HC4911



HS4911



HD4911M2



HC4911/2



HS4911/2

**2-FONKSİYON TUŞ KAPAĞI**

Baskısız

Referans Tanım

**HD4911** 2 fonksiyonlu sembolsüz tuş kapağı - 1 mod.  
**HC4911**  
**HS4911****HD4911M2** 2 fonksiyonlu sembolsüz tuş kapağı - 2 mod.  
**HC4911/2**  
**HS4911/2**

HD4915



HC4915



HS4915



HD4915M2



HC4915/2



HS4915/2

**1-FONKSİYON TUŞ KAPAĞI**

Baskısız

Referans Tanım

**HD4915** Tek fonksiyonlu sembolsüz tuş kapağı - 1 mod.  
**HC4915**  
**HS4915****HD4915M2** Tek fonksiyonlu sembolsüz tuş kapağı - 2 mod.  
**HC4915/2**  
**HS4915/2**

# MY HOME

## KABLOSUZ OTOMASYON

### ORTAK ÜRÜNLER

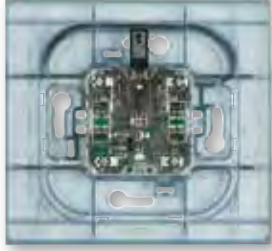

HA4572



HB4572



H4572PI

### BEYAZ



HD4919

### ALÜMİNYUM



HC4919

### ANTRASİT



HS4919

### RF KONTROL CİHAZLARI

#### Pilsiz

Referans Tanım

**HA4572** Düz kablosuz radyo anahtarı – 1 modül HC/HS4919 tuş kapağı ve 2 modül dikdörtgen çerçeve ile tamamlanır. 3V CR2032 lityum pil ile çalışır

**HB4572** HA4572 gibi eliptik çerçeve ile tamamlanır

**H4572PI** 2 fonksiyonlu sıva altı kablosuz radyo anahtarı – 1 modül HC/HS4919 tuş kapağı ile tamamlanabilir. CR2032 pil ile çalışır

### RF KONTROLLER İÇİN TUŞ KAPAKLARI

#### Pilli

Referans Tanım

**HD4919** HA4572, HB4572, H4572PI,  
**HC4919** için tuş kapağı  
**HS4919**

**ORTAK ÜRÜNLER**

HA4572SB



HB4572SB

**BEYAZ**

HD4919SB

**ALÜMİNYUM**

HC4919SB

**ANTRASİT**

HS4919SB

**ORTAK ÜRÜNLER**

3527



3528

**KONTROL CİHAZLARI**
**Pilsiz**

Referans Tanım

**HA4572SB** Düz kablosuz radyo anahtarı – 1 modül HD/HC/HS4919 tuş kapağı ve 2 modül dikdörtgen çerçeve ile tamamlanır. Pilsiz çalışır. MY HOME kullanımlarında özel birim olan HD/HC/HS4575SB ile çalışır

**HB4572SB** HA4572SB gibi ancak eliptik çerçeve ile tamamlanır

**RF KONTROL CİHAZLARI İÇİN TUŞ KAPAKLARI**
**Pilsiz**

Referans Tanım

**HD4919SB** HA4572SB, HB4572SB, L4572SB

**HC4919SB**

**HS4919SB**

**RF UZAKTAN KUMANDA**

Referans Tanım

**3527** 6 butonlu uzaktan kumanda - engelli kişilerin kullanabilmesi için ergonomik tasarım - 2 adet şarj edilebilir 1.5V AA alkalin pil (birlikte) temin edilir

**3528** 4 butonlu uzaktan kumanda - 3V CR2032 pil

# MY HOME

## Kablosuz otomasyon

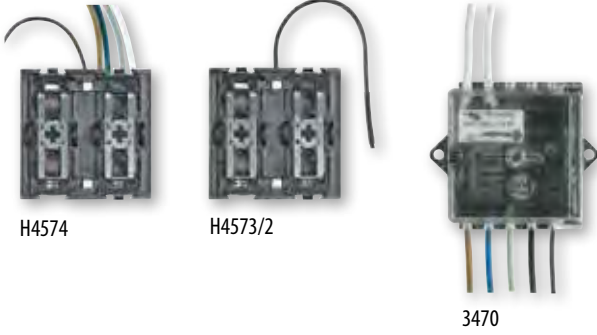

H4574

H4573/2

3470

### SIVA ALTI RF AKTUATÖRLER

Referans	Tanım
<b>H4574</b>	İki kontaklı RF aktuatör - 230Vac besleme - 0,2:2A rezistif ve akkor lambalar, 0,2:2A cosφ 0.5 ferromanyetik transformatörler ve 0.05:0.3A floresan lambalar ve elektronik transformatörler - 2 modül tuş kapaklarıyla kullanılır.
<b>H4573/2</b>	RF jaluzi aktuatörü - 230Vac besleme - 500W - aynı zamanda tekil yükler: 2A rezistif ve akkor lambalar 2A cosφ 0.5 ferromanyetik transformatörler - 2 modül tuş kapaklarıyla kullanılır.
<b>3470</b>	Basit RF aktuatör - 230 Vac besleme - tekil yükler : 2A rezistif ve akkor lambaları, 2A cosφ 0.5 ferromanyetik transformatörler.



F470/1

F470/2

### MODÜLER RF AKTUATÖRLER

Referans	Tanım
<b>F470/1</b>	Tek röleli RF aktuatör - 230Vac besleme - tekil yükler : 10A rezistif, 6A akkor lambalar, 2A cos 0.5 ferromanyetik transformatörler ve 2A floresan lambalar ve elektronik transformatörler - 2 DIN modül
<b>F470/2</b>	İki röleli RF aktuatör - 230Vac besleme - tekil veya ikili yük: 6A rezistif, 2A akkor lambalar, 2A cos 0.5 ferromanyetik transformatörler, 0.3A floresan lambalar ve elektronik transformatörler, 500W motorlar - 2 DIN modül

**ORTAK ÜRÜNLER**

Önden görünüş



3526



3526/10



3526/16

**BEYAZ**
**ALÜMİNYUM**
**ANTRASİT**

 HD4575  
HD4575SB

 HC4575  
HC4575SB

 HS4575  
HS4575SB

HD4576



HC4576



HS4576

**TAŞINABİLİR RF AKTUATÖRLER**

## Referans

## Tanım

<b>3526</b>	10A, 16A schuko priz ve universal fişli mobil aktüatör. Tek yük için 16A resistif, 10A akkor lambalı, 4A cosφ 0.5 ferromanyetik transformatörleri ve 4A floresan lambaları kontrol edebilir.
<b>3526/10</b>	10A, 16A schuko priz ve universal fişli mobil aktüatör. Tek yük için 16A resistif, 10A akkor lambalı, 4A cosφ 0.5 ferromanyetik transformatörleri ve 4A floresan lambaları kontrol edebilir.
<b>3526/16</b>	10A, 16A schuko priz ve universal fişli mobil aktüatör. Tek yük için 16A resistif, 10A akkor lambalı, 4A cosφ 0.5 ferromanyetik transformatörleri ve 4A floresan lambaları kontrol edebilir.

**RF ALICI ARAYÜZLER**

## Referans

## Tanım

<b>HD4575</b> <b>HC4575</b> <b>HS4575</b>	RF radyo alıcı - 27V dc besleme - 2 modül
<b>HD4576</b> <b>HC4576</b> <b>HS4576</b>	RF radyo sinyal dönüştürücü - 27Vdc besleme - 2 modül
<b>HD4575SB</b> <b>HC4575SB</b> <b>HS4575SB</b>	HA/HB4572SB için RF alıcı arayüz - 27Vdc besleme - 2 modül



# MY HOME

## HI-FI stereo müzik yayın sistemi

### ORTAK ÜRÜNLER



346830



F441

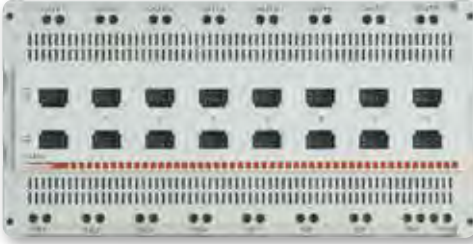

F441M



F500  
F500COAX



L4561N



3495

### AUDIO - VIDEO DAĞITICI

Referans	Tanım
<b>346830</b>	Video adaptör - basit müzik yayın sistemleri için tek bir ses kaynağı bağlanabilir – 2 DIN modül
<b>F441</b>	DIN rayları için 4 giriş 4 çıkışlı modüler cihaz. 4 adet 2 kablolu audio ve video giriş panelinin çıkışlarını 4 adet 2 kablolu audio/video ana linyeye dağıtır
<b>F441M</b>	Çok kanallı matris, 2 kablolu interkom sistemlerinin ve stereo ses kaynak sinyallerinin dağıtımını anahtarlama fonksiyonlarının gerçekleştirilmesi - 8 giriş (ilk dördü iki kablolu audio/video sistemleri ve diğerleri stereo ses kaynakları) ve 8 çıkış 100W modülü

### SES KAYNAKLARI

Referans	Tanım
<b>F500N</b>	RDS stereo radyo – 4 DIN modül
<b>L4561N</b>	Stereo kaynakları kızıl ötesi uzaktan kumanda ile kontrol etmek için cihaz – kaynakların amplifikatör üzerinden veya özel komutlarla kontrol imkânı – 4 DIN modül – RCA/RCA kablo ve IR vericisini bağlamak için jak ile birlikte
<b>3495</b>	Class I stereo kaynaklarını izole etmek için izolatör – iki çift RCA dışı bağlayıcı ile birlikte; "IN" stereo kaynaklarını bağlamak için (stereo sistemi, CD çalar veya Pc audio "OUT" çıkışı) ve "OUT" RCA girişlerini veya stereo kumanda cihazlarını bağlamak için – class II stereo kaynakları bağlanabilir (iki veya daha fazla class II stereo kaynağı olduğu zaman)

### BEYAZ



HD4560

### ALÜMİNYUM



HC4560

### ANTRASİT



HS4560

### SES KAYNAKLARI

Referans	Tanım
<b>HD4560</b>	Ses kaynağını kontrol etmek için sıva altı RCA girişi
<b>HC4560</b>	2 modül
<b>HS4560</b>	

**ORTAK ÜRÜNLER**

F502



H4562



H4651M2

**AMPLİFİKATÖRLER**

Referans	Tanım
<b>F502</b>	Modüler stereo amplifikatör - 4 DIN modül - 230Vac besleme
<b>H4562</b>	Sıva altı amplifikatör - 2 modül - AXOLUTE tuş kapaklarıyla tamamlanır
<b>H4651M2</b>	Amplifikatörleri yönetmek için özel kumanda, cihazları açıp kapamak, ses şiddetini ayarlamak, kaynak değiştirmek ve programlı radyo istasyonu değiştirmek için ışıklı tuş kapağı ile tamamlanır - 2 modül için



F503

**GÜÇ AMPLİFİKATÖRÜ**

Referans	Tanım
<b>F503</b>	Stereo amplifikatör - SCS BUS üzerinde gelen ve alternatif olarak AUX girişine (MP3 çalar, CD çalar vb.) bağlı ses kaynaklarından gelen sinyali tekrar oluşturur. Yüksek ve düşük ton ayarları mevcuttur, 10 adet ekolayzır ayarı vardır aynı zamanda 10 adet kişiselleştirilebilir ekolayzır ayar hafızası bulunur. Bütün parametreler OLED grafik ekrandan görüntülenebilir

**BEYAZ**
**ALÜMİNYUM**
**ANTRASİT**

HD4563



HC4563



HS4563

**ROTATİF KONTROL**

Referans	Tanım
<b>HD4563</b>	Amplifikatörleri yönetmek için özel kumanda, cihazları açıp kapamak, ses şiddetini ayarlamak, kaynak değiştirmek ve programlı radyo istasyonu değiştirmek için - 2 modül
<b>HC4563</b>	
<b>HS4563</b>	

**SOFT TOUCH KONTROL**

Referans	Tanım
<b>HD4653M2</b>	Amplifikatörleri açıp - kapamak, ses şiddetini ayarlamak için soft touch kontrol - 2 modül
<b>HC4653/2</b>	
<b>HS4653/2</b>	
<b>HD4653M3</b>	Amplifikatörleri açıp - kapamak, ses şiddetini ayarlamak için soft touch kontrol - 3 modül
<b>HC4653/3</b>	
<b>HS4653/3</b>	



HD4653M2 - HD4653M3



HC4653/2 - HC4653/3



HS4653/2 - HS4653/3

# MY HOME

## Hi-Fi stereo müzik yayın sistemi

### BEYAZ CAM



HD4657M3



HD4657M4

### WHICE



HC4657M3



HC4657M4

### NIGHTER



HS4657M3



HS4657M4

### BEYAZ



HD4685

### ALÜMİNYUM



HC4685

### ANTRASİT



HS4685

### Ortak ürünler



HA4572SB



HB4572SB



3527

### DİJİTAL CAM ANAHTARLAR

Tekele yükler veya yük grupları (aydınlatma ve jaluzi), müzik yayın sistemi, temel interkom fonksiyonları (kapı açma) kontrolü için kullanılır.

Konfigürasyon iki farklı yoldan yapılır:

fiziksel (konfigüratörlerin yuvalarına takılması suretiyle veya sanal olarak. Aydınlık düzeyi ayarlanabilir LED ler ile donatılmıştır.

Referans Tanım

BEYAZ CAM	
HD4657M3	6 tuş - 3 modül
HD4657M4	8 tuş - 4 modül
WHICE	
HC4657M3	6 tuş - 3 modül
HC4657M4	8 tuş - 4 modül
NIGHTER	
HS4657M3	6 tuş - 3 modül
HS4657M4	8 tuş - 4 modül

### LOCAL DISPLAY

Referans Tanım

HD4685	OLED teknolojisi ile üretilen dokunmatik ekran ile otomasyon, sıcaklık kontrol ve müzik yayın sistemini kontrol etmek mümkündür
HC4685	
HS4685	

### DOKUNMATİK EKРАН (H4684) ADAPTÖRÜ

Referans Tanım

3496	DOKUNMATİK EKРАН (H4684) için aksesuar : PC (server) üzerindeki müzik dosyalarını ve aynı zamanda IP radyo içeriği müzik yayın sistemi üzerinden çalmaya yarar - DOKUNMATİK EKРАН'ın arkasına monte edilir.
------	---

### RADYO KONTROL MEKANİZMALAR

Pilli

Referans Tanım

HA4572SB	Radyo kontrol, 1 modül AXOLUTE tuş kapakları ile (ref. HD/HC/HS-4919SB) ve 2 modül dikdörtgen çerçeveler ile tamamlanır, batarya gerektirmez - iki tarafı yapışkanlı bant ya da vidalarla siva üstü montaj - HD/HC/HS 4575SB referanslı özel arayüz ile MY HOME uygulamalarında kullanılır.
HB4572SB	yukardaki gibi - eliptik çerçevelerle tamamlanır
3527	6 liht butonu ile radio uzaktan kumanda, grafik etiketler - ergonomik yapı ve engelli kişilerin kullanımı için ayarlanabilir - 2 adet 1,5 V AA alkalin bataryalar ile beslenir ve birlikte temin edilir.

**BEYAZ****ALÜMİNYUM****ANTRASİT**

HD4575



HC4575



HS4575

**RF ALICI ARAYÜZLER**

Referans

Tanım

**HD4575**

RF radyo alıcı - 27V dc besleme

**HC4575**

- 2 modül

**HS4575**

HD4654



HC4654



HS4654

**KIZIL ÖTESİ ALICI**

Referans

Tanım

**HD4654**

3529 referanslı uzaktan kumanda ile kullanılan IR alıcısı. F420

**HC4654**

senaryo modülüne yüklenmiş olan IG senaryoyu da

**HS4654**

kontrol edebilir

**ORTAK ÜRÜNLER**

3529

**UZAKTAN KUMANDA**

Referans

Tanım

**3529**

IR uzaktan kumanda (aynı odada 16 alıcıya kadar)

- 16 iletişim kanalı doğrudan seçilebilir

- 2x1.5V AAA pil ile birlikte

# MY HOME

## HI-FI stereo müzik yayın sistemi

### BEYAZ



HD4565

### ALÜMİNYUM



HC4565

### ANTRASİT



HS4565

### HOPARLÖRLER

Referans	Tanım
<b>HD4565</b> <b>HC4565</b> <b>HS4565</b>	16 ohm hoparlör (506E kasa ile) - 12W
<b>H4570</b>	8 ohm hoparlör (16104 kasa ile) - 100W
<b>L4567</b>	8 ohm sıvaüstü hoparlör - 40W
<b>L4569</b>	8 ohm dış mekan hoparlör - 70W
<b>L4566</b>	8 ohm tavan tipi hoparlör - 100W
<b>L4566/10</b>	8 ohm tavan tipi (10 cm çaplı) hoparlör - 100W
<b>L4568</b>	8 ohm asma tavan tipi beyaz (60x60 cm) hoparlör - 50W

### Ortak ürünler



H4570



L4567



L4569



L4566

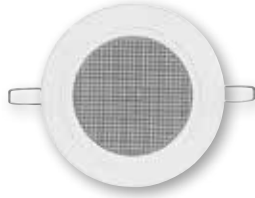

L4566/10

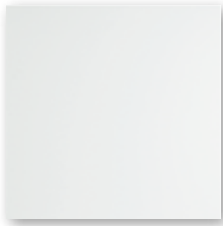

L4568

### BEYAZ



349418

### ALÜMİNYUM



349414

### ANTRASİT



349415

### ARAYÜZ İÇİN KONNEKTÖRLER

Referans	Tanım
<b>349413</b>	Arayüz L4561N in BUS'a bağlanması için 8 - pinli konnektör - beyaz renkte
<b>349414</b>	yukarıdaki gibi - alüminyum renkte
<b>349415</b>	yukarıdaki gibi - antrasit renkte

**BEYAZ**
**ALÜMİNYUM**
**ANTRASİT**

HD4911AF



HD4911AI



HC4911AF



HC4911AI



HS4911AF



HS4911AI



HD4911BE



HD4911BF



HC4911BE



HC4911BF



HS4911BE



HS4911BF

**İŞIKLANDIRILABİLİR TUŞ KAPAKLARI**

Referans

Tanım

**HD4911AF**  
**HC4911AF**  
**HS4911AF**

ON-OFF-GEN sembolü ışıklandırılabilir tuş kapağı

**HD4911AI**  
**HC4911AI**  
**HS4911AI**

ON-OFF-ayarlanabilir sembolü ışıklandırılabilir tuş kapağı

**HD4911BE**  
**HC4911BE**  
**HS4911BE**

Müzik yayını sembolü sol anahtarı ışıklandırılabilir tuş kapağı

**HD4911BF**  
**HC4911BF**  
**HS4911BF**

Müzik yayın sistemi fonksiyonları için ışıklandırılabilir tuş kapağı



HD4919SB



HC4919SB



HS4919SB

**RF KONTROL CİHAZLARI İÇİN TUŞ KAPAKLARI**

Referans

Tanım

**HD4919SB**  
**HC4919SB**  
**HS4919SB**

LHA/HB4572SB için tuş kapakları



# MY HOME

## HI-FI stereo müzik yayın sistemi



346000



346030



336904



3499



3515



3559



335919



346841



346851



346850

### GÜÇ KAYNAĞI

Referans Tanım

**346000** Ses sistemi için güç kaynağı - giriş 230 V a.c çıkış 27Vd.c.-maks. enerji çekimi 1.2mA - 8 DIN modülü

**346030** Vido adaptör entegre edilmiş güç kaynağı - sadece 1 ses kaynağı kullanılan basit müzik yayın sistemleri için - 2 OW modül

### KABLO

Referans Tanım

**336904** 2 iletkenli burgulu kablo - CEI 20-13 ve CEI 20-14 standartlarına uygundur - 200 m

### HAT SONLANDIRICI

Referans Tanım

**3499** Hat sonlandırıcı - audio/video dağıtıcı çıkışlarında kullanılmak üzere

### ÇEŞİTLİ AKSESUARLAR

Referans Tanım

**3515** Yedek klemens

**335919** Programlama için seri PC bağlantı kablosu

**3559** Yukardaki gibi - USB port bağlantısı için

### ENTEGRASYON VE SİSTEM GENİŞLETME ÜRÜNLERİ

Referans Tanım

**346841** Kat dağıtım bloğu - F441 ve F502 ile birlikte kullanılır

**346851** Sistem genişletme modülü: 140 hoparlöre kadar sistem genişletmekte kullanılır - 4 DIN modül

**346850** Daire arayüzü: Bticino interkom sisteminin MY HOME uygulamalarıyla (Müzik yayın sistemi, Otomasyon vs.) entegrasyonunda kullanılır - 4 DIN modül

# MY HOME

## Hırsız alarm

### ORTAK ÜRÜNLER



3485



3486

### MERKEZİ ÜNİTE - TELEFON ARAMASI

Referans	Tanım
<b>3485</b>	POLYX ALARM merkezi ünitesi - kendi kendine öğrenme özelliğiyle. Transponder ve klavye aracılığıyla kontrol. 72 sensör ve 8 zon kontrolü. 16 senaryo programlama imkanı. Alarmı telefonlara yönlendirmek için PSTN arama cihazıyla donatılmıştır. TiSecurity yazılımıyla programlanır. Ambalaj içerisinde yer alan metal kaide ile duvara montaj. 3506 pil ile birlikte kullanılır.
<b>3486</b>	Merkezi ünite yukarıdaki gibi. IR uzaktan kumanda, transponder ve klavye aracılığıyla kontrol. Alarmı telefonlara yönlendirmek için PSTM ve GSM arama cihazıyla donatılmıştır. Ambalaj içerisinde yer alan metal kaide ile duvara montaj. 3507/6 ile birlikte kullanılır.
<b>3483</b>	Merkezi ünite anten için koaksiyel kablo, Ref. 3486 - L = 3.5 m.
<b>3484</b>	GSM anteni için koruma

### BEYAZ

### ALÜMİNYUM

### ANTRASİT



HD4601



HC4601



HS4601

### MERKEZİ ÜNİTE

Referans	Tanım
<b>HD4601</b>	Merkezi ünite-kendi kendine öğrenme özelliğiyle. Transponder ve klavye aracılığıyla kontrol. 36 sensör ve 4 zon kontrolü. 4 senaryo programlama imkanı. Alarm sinyali aktuatörü: kapılar ve camlar gibi, NK kontaklı bağlantı terminali. Sıva altı montaj ref. 500E kasa ile.
<b>HC4601</b>	
<b>HS4601</b>	
<b>3485B</b>	POLYX ALARM merkezi ünitesi - kendi kendine öğrenme özelliğiyle. Transponder ve klavye aracılığıyla kontrol. 36 sensör ve 4 zon kontrolü. 4 senaryo programlama imkanı. Ambalaj içerisinde yer alan metal kaideyle duvara montaj. 3506 pil ile birlikte



3485B

# MY HOME

## Hırsız alarm

### BEYAZ



HD4603Z4



HD4607Z4



HD4603Z8



HD4608



HD4606

### ALÜMİNYUM



HC4603/4



HC4607/4



HC4603/8



HC4608



HC4606

### ANTRASİT



HS4603/4



HS4607/4



HS4603/8



HS4608



HS4606

### KONTROL VE İZLEME CİHAZLARI

Referans Tanım

**HD4603Z4** Alıcı-uzaktan kumanda aracılığıyla sistemi açmak/kapatmak  
**HC4603/4** 4 zon kontrolü için tuşlar - zon ve sistem durumunu ledler  
**HS4603/4** aracılığıyla gösterir - sesli ve ışıklı ikazları etkisizleştirilebilir.

**HD4607Z4** Yukarıdaki gibi - transponder (ref. 35305 ve ref. 3540) aracılığıyla  
**HC4607/4** sistemi açmak/kapatmak  
**HS4607/4**

### ZON GENİŞLETME MODÜLÜ

Referans Tanım

**HD4603Z8** Bölümlendirilebilir zonları genişletmek için modül - 5:8 zon kontrolü  
**HC4603/8** için tuşlar - zon durumu izlemek için ledler - sesli ve ışıklı  
**HS4603/8** ikazlar etkisizleştirilebilir.

### KONTROL VE İZLEME CİHAZLARI

Referans Tanım

**HD4608** Sistemi açmak/kapatmak için numerik tuş takımıyla donatılmıştır.  
**HC4608** Ref. 3485/B, ref. 3486 ve ref. HD/HC/HS4601 veya transponder kart.  
**HS4608** Bütün bilgilerin görüntülenmesi, bazı fonksiyonların kontrolü.  
Sıvaaltı kasa 500E ile montaj gerçekleştirilir. L4380/B pil ile kullanılır.

**HD4606** Numerik tuş takımı, merkezi kontrol ünitesinde kaydedilmiş  
**HC4606** fonksiyonlar, ref. 3485/B, ref. 3486 ve ref. HD/HC/HS4601.  
**HS4606**

**BEYAZ**
**ALÜMİNYUM**
**ANTRASİT**

HD4604



HC4604



HS4604



HD4607



HC4607



HS4607



HD4605



HC4605



HS4605

**KONTROL VE İZELEME CİHAZLARI**

## Referans

## Tanım

**HD4604**
**HC4604**
**HS4604**

Uzaktan kumanda ile sistemi devreye almak/çıkarmak için alıcı ünite - LED ler ile sistem durum sinyali verme - ışıklı ve sesli sinyalleri devre dışı bırakma imkanı

**HD4607**
**HC4607**
**HS4607**

Transponder (aktarıcı) okuyucusu; transponder rozet ile sistemi devreye sokar ve çıkarır - 30 kadar aktarıcı hafızasında saklayabilir - LED ışıklar ile sistem durumunu gösterme - diğer fonksiyonlar işlemleri için yardımcı kanallar içerir

**HD4605**
**HC4605**
**HS4605**

Mekanik anahtar vasıtasıyla sistemi kapatmak ve kilitlemek için modül - LED ışıklar ile sistem durum sinyali verme - anahtar deliği kapağı ile donatılmış - 10.000 kombinasyonlu kilit anahtarı

**ORTAK ÜRÜNLER**

4050



3540



3530S

**UZAKTAN KUMANDA**

## Referans

## Tanım

**4050**

Taşınabilir kızıl-ötesi uzaktan kumanda;  
- sistemi aktif ve pasif yapmak için  
- merkezi ünite tarafından otomatik kodlanır  
- 50,000 açma/kapama

**TRANSPONDER**

## Referans

## Tanım

**3530S**

Taşınabilir ince kart

**3540**

Taşınabilir halka

# MY HOME

## Hırsız alarm

### BEYAZ



HD4610



HD4611



HD4613

### ALÜMİNYUM



HC4610



HC4611



HC4613

### ANTRASİT



HS4610



HS4611



HS4613

### IR PASİF DEDEKTÖRLER

Referans Tanım

**HD4610** Kızılötesi hacimsel hareket dedektörü – hafızalı LED alarm sinyalli  
**HC4610** 14 kanallı – yardımcı ön-alarm kanalı devreye sokulabilir  
**HS4610** – 8 metre kapasiteli, dikey ve yatay 0° - 105°, 3 kademeye bölünmüş

**HD4611** Yukarıdaki gibi hacimsel varlık dedektörü – dikey ve yatay 0°  
**HC4611** - 105°, – 2 aks üzerinde oynayabilen lens  
**HS4611**

**HD4613** Kızılötesi varlık dedektörü, hareket tespit için mikro dalga (MW)  
**HC4613** dedektörü çift teknoloji hacimsel hareket dedektörü. Her iki tespit  
**HS4613** birden yapıldığında alarm devreye girer

**N4640** 105° algılama açılı, 8 metre kapasiteli mini IR hareket dedektörü –  
hafızalı LED li alarm sinyali – Yardımcı kanal aktive edilebilir - belli bir  
açıyla eğik olarak duvara monte edilir

**N4640B** yukarıdaki gibi - kapasite 6 metre

### ORTAK ÜRÜNLER



N4640  
N4640B

**BEYAZ**
**ALÜMİNYUM**
**ANTRASİT**

 HD4612  
HD4612V12

 HC4612  
HC4612/12

 HS4612  
HS4612/12

**ORTAK ÜRÜNLER**

3510



3513



3511



3510M



3510PB



3512



3516



3514



3480



F482

 3518 - 3519  
3518/50 -  
3518/150

**IR PASİF DEDEKTÖR**

## Referans

## Tanım

<b>HD4612</b> <b>HC4612</b> <b>HS4612</b>	NK elektromanyetik kontak arayüz modülü - dengelenmiş ve dengelenmemiş kontak koruma hattına bağlanabilir - hafızalı LED li alarm sinyali - Yardımcı kanal aktive edilebilir.
<b>HD4612V12</b> <b>HC4612/12</b> <b>HS4612/12</b>	Panjurları korumak için kablo dedektörü için 12V arayüz modülü - NK/NA ve cam kırılma dedektörler uygulanabilir (ref. 3516)
<b>3510</b>	Dedektörler ve koruma line arasında arayüz görevi gören NK elektromanyetik kontak - sıvaaltı montaja uygundur.
<b>3510M</b>	Yukarıdaki gibi sensör - pirinç malzeme, yüksek mekanik dayanıklılık - ferromanyetik olmayan pencere ve kapı çerçevelerinde kullanılır.
<b>3510PB</b>	Yukarıdaki gibi sensör - pirinç malzeme, yüksek mekanik dayanıklılık - her türlü pencere ve kapı çerçevelerinde ve zırlı kapılarda kullanılır.
<b>3511</b>	Yukarıdaki gibi sensör - görülebilir şekilde montaj için kullanılan tip
<b>3512</b>	Yukarıdaki gibi sensör - döner kapı ve sürgülü kapı düzenleri için dökme alüminyum malzeme. Yere monte edilir.
<b>3513</b>	Yukarıdaki gibi sensör - ana kapıların metal yüzeylerine görülebilir şekilde monte edilir.
<b>3514</b>	Panjurları korumak için dedektör - aynı zamanda, çevreyi kontrol edebilen mıknatıs görevi görür.
<b>3516</b>	Piezoelektrik cam kırılma dedektör. Çift taraflı yapışkan bant ile takılır.
<b>3518/50</b>	Aktif kızıl ötesi (IR) bariyer; pencere ve kapıları korumak için. Cihaz iki kolondan oluşur: biri VERİCİ (TX) olarak çalışır, diğeri ALICI (RX) olarak. Bir çok IR ışınları kesildiğinde alarm hemen tetiklenir - uzunluk 0,5 metre.
<b>3518</b>	Yukarıdaki gibi - uzunluk 1 metre
<b>3518/150</b>	Yukarıdaki gibi - uzunluk 1,5 metre
<b>3519</b>	Yukarıdaki gibi - uzunluk 2 metre
<b>3480</b>	NK elektromanyetik kontak arayüz modülü - dengelenmiş ve dengelenmemiş 2 kontak line hattına bağlanabilir - hafızalı LED li alarm sinyali.
<b>F482</b>	NK elektromanyetik kontak arayüz modülü - dengelenmiş ve dengelenmemiş 2 kontak line hattına bağlanabilir - hafızalı LED li alarm sinyali - 2 DIN modül



# MY HOME

## Hırsız alarm

### BEYAZ



HD4614



HD4615

### ALÜMİNYUM



HC4614



HC4615

### ANTRASİT



HS4614



HS4615

### TEKNİK ALARM CİHAZLARI

Referans	Tanım
<b>HD4614</b> <b>HC4614</b> <b>HS4614</b>	Röle üzerinde çıkış ile çoklu konfigüre edilebilen aktüatör modül- - C-NO-NC kontakları, 24V 0.4A cosφ 0.4 – alarmı tekrar etmek, harici bir cihazı devreye sokmak, sistem durumunu tekrar etmek ve pilin bittiğini bildirmek için kullanılır.
<b>HD4615</b> <b>HC4615</b> <b>HS4615</b>	NO veya NC yardımcı kontakları için arayüz modülü - girişler 5 – 12V a.c./d.c. optik olarak izole edilmiş - "yaşlı insanları yardım talebi", "panik önleyici" ve benzeri teknik alarm sinyalleri dahil çeşitli işlevler için kullanılır.



HD4511V12



HD4512V12



HC4511/12



HC4512/12



HS4511/12



HS4512/12

### GAZ DEDEKTÖRLERİ

Referans	Tanım
<b>HD4511V12</b> <b>HC4511/12</b> <b>HS4511/12</b>	Görsel ve sesli alarmlı (85dB) metan gazı dedektörü 12Va.c./d.c. - 2 modül
<b>HD4512V12</b> <b>HC4512/12</b> <b>HS4512/12</b>	Görsel ve sesli alarmlı (85dB) LPG dedektörü 12Va.c./d.c. - 2 modül

**NOT:** Hırsız alarm sistemiyle entegre edilmiş gaz dedektörlerinin kullanılmasıyla teknik alarm telefon çağrısı yapılabilir (harici kanal arayüzü, HD/HC/HS4615, kullanın)

**BEYAZ**
**ALÜMİNYUM**
**ANTRASİT**

HD4618



HC4618



HS4618

**ORTAK ÜRÜNLER**

3440

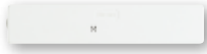

3442



3444



3445



3448



348220

**TEKNİK ALARM CİHAZLARI**

Referans

Tanım

**HD4618**
**HC4618**
**HS4618**

RF alıcı - kablolu hırsız alarm cihazları ile kablosuz hırsız alarm sensörleri arasında iletişim sağlar - aynı zamanda acil çağrı fonksiyonu için ref. 3448 ile birlikte kullanılabilir.

**IR PASİF DEDEKTÖRLER**

Referans

Tanım

**3440**

Kızıl ötesi varlık dedektörü - alarm LED- 90° 12 metre algılama, 4 seviyeye bölünme 17 dalga, 3.6V tip AA pil ile birlikte.

**MANYETİK DEDEKTÖRLER**

RF manyetik ve cam kırılma dedektörleri

Referans

Tanım

**3442**

manyetik açılma dedektörü - kapılar ve camlar için. 3.6V tip 1/2AA pil ile birlikte

**3444**

piezoelektrik dedektör - camlar için - 3.6V tip 1/2 AA pil ile birlikte.

**RF KABLOLU DEDEKTÖR**

Jaluziler için

Referans

Tanım

**3445**

Jaluziler veya sargılı perdeler için dedektör 3.6V tip 1/2AA pil ile birlikte.

**ACİL DESTEK ÇAĞRISI İÇİN UZAKTAN KUMANDA**

Referans

Tanım

**3448**

Acil çağrı sinyali göndermek için RF uzaktan kumanda - HC/HS4618 RF alıcı ile otomatik olarak programlanabilir. 3V CR2032 pil ile birlikte - pil ömrü 3 yıl.

**348220**

2 tuşlu uzaktan kumanda - sistemi açmak ve kapatmak için. Açık alanda maks. 50 m 3V 2032 pil ile birlikte. HD/HC/HS4618 ile birlikte kullanılmalıdır.

# MY HOME

## Hırsız alarm

### ORTAK ÜRÜNLER

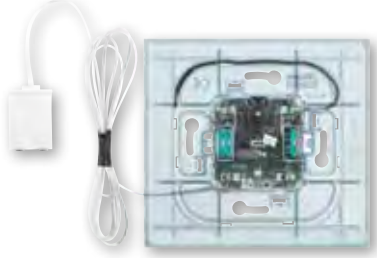

HA4619

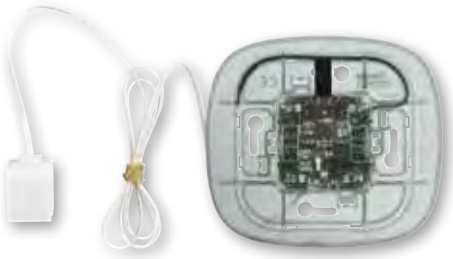

HB4619



3482

### SU BASKINI DEDEKTÖRLERİ

Referans	Tanım
<b>HA4619</b> <b>HB4619</b>	Herhangi bir tip sıvı kaçağını algılamak için su baskını dedektörü - 3V CR2032 pil ile birlikte - tuş kapakları HD/HC/HS4919 ile kullanılabilir.
<b>3482</b>	Su baskını dedektörü - kontak arayüzü ref. 3480 ile birlikte kullanılmalıdır (teknik alarm modunda).

### BEYAZ



HD4919SB

### ALÜMİNYUM



HC4919SB

### ANTRASİT



HS4919SB

### TUŞ KAPAKLARI

Referans	Tanım
<b>HD4919SB</b> <b>HC4919SB</b> <b>HS4919SB</b>	Su baskını dedektörleri HA4619 ve HB4619 için tuş kapağı

**ORTAK ÜRÜNLER**

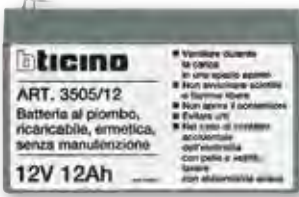
 4072A  
4072L

3505/12

**HARİCİ SİREN - BESLEMELİ**

Referans	Tanım
<b>4072L</b>	Harici siren, bütün sisem için takılacak pil içerir - 12V 12Ah pil (ref. no 3505/12) takılmalıdır - ses şiddeti 105dB(A) 3metrede - zenon lamba ile ışık sinyali vericisi - köpük önleyici ızgara - çekip çıkarmaya ve açılmaya karşı korunmuş - E46ADCN güç kaynağı ile birlikte kullanılır.
<b>4072A</b>	Harici siren - kontrol ünitesi (1 veya 4 bölge) vasıtasıyla alarm süresi 0 ile 10 dakika arasında ayarlanabilir - 12V 7Ah pil takılmalıdır - ses şiddeti 105dB(A) 3 metrede - zenon lamba ile ışık sinyali verici - köpük önleyici ızgara - çekip çıkarmaya ve açılmaya karşı korunmuş - E47ADC güç kaynağı ile birlikte kullanılır.
<b>3505/12</b>	12V 12Ah pil

**BEYAZ**

HD4070

**ALÜMİNYUM**

HC4070

**ANTRASİT**

HS4070

**DAHİLİ SİREN**

Referans	Tanım
<b>HD4070</b>	506E buata monte edilen dahili siren - 6V 0,5Ah pil (ref. no 3507/6) ile takılmalıdır - ses şiddeti 90dB(A) 3 metrede - çekip çıkarmaya ve kurcalamaya karşı dayanıklıdır.
<b>HC4070</b>	
<b>HS4070</b>	

**ORTAK ÜRÜNLER**

3507/6

**PİL**

Referans	Tanım
<b>3507/6</b>	6V 0.5Ah pil - dahili siren ve merkezi ünite referans 3486 için

# MY HOME

## Hırsız alarm



E46ADCN

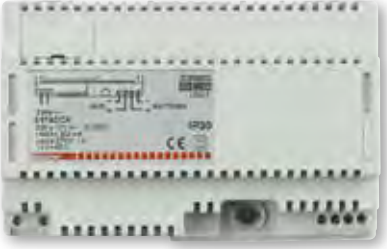

E47ADCN



F115/8A



F115/8B



3515



L4630



L4669S



335919  
3559



3507/6  
3506



L4380/B

### GÜÇ KAYNAĞI VE HIRSIZ ALARM KİTİ

Referans	Tanım
<b>E46ADCN</b>	Hırsız alarm sistemi için güç kaynağı, harici siren 4072L ile birlikte – kullanılmak için - giriş 230V a.c. çıkış 27Vd.c. SELV – maksimum akım 450mA ile çalışır – 8 DIN modülü
<b>E47ADCN</b>	Yukarıdaki gibi güç kaynağı, harici siren 4072A ile birlikte kullanılmak için

### GÜÇ KAYNAĞI VE PİL İÇİN SIVA ÜSTÜ KASALAR

Referans	Tanım
<b>F115/8A</b>	E47ADC referanslı güç kaynağı montajı için siva üstü kasa
<b>F115/8B</b>	E47ADC güç kaynağı ve 12x7ah batarya montajı için siva üstü kasa

### KLEMENS

Referans	Tanım
<b>3515</b>	Yedek klemens

### TAMPER

Referans	Tanım
<b>L4630</b>	Alarm cihazları için anti-tamper

### BAĞLANTI KABLOSU

Referans	Tanım
<b>L4669S</b>	Ekransız SCS hırsız alarm sistemleri için 2'li esnek kablo - yalıtım 300/500V – CEI 46-5 ve CEI 20-20 standartları ile uyumludur – 100 metre
<b>336904</b>	SCS kablo yeraltında kullanım için uygun
<b>335919</b>	Merkezi üniteleri programlamak için seri PC kablo
<b>3559</b>	Yukarıdaki gibi - USB port bağlantılı

### PİLLER

Referans	Tanım
<b>3507/6</b>	6V 0.5Ah pil - dahili siren ve merkezi ünite ref. 3486
<b>3506</b>	7V pil merkezi ünite ref. 3485
<b>L4380/B</b>	Pil - ref. HD/HC/HS4601, HD/HC/HS4608

MY HOME  
Sıcaklık kontrol



BEYAZ

ALÜMİNYUM

ANTRASİT



HD4695



HC4695



HS4695

4 ZON MERKEZİ ÜNİTE

Referans Tanım

<b>HD4695</b>	4 zon merkezi ünite
<b>HC4695</b>	
<b>HS4695</b>	

ORTAK ÜRÜNLER



3550

99-ZON MERKEZİ ÜNİTE

Referans Tanım

<b>3550</b>	maksimum 99 zona kadar sıcaklık kontrolü yapılabilir - TiThermo yazılımı, PC üzerinden programlarda kullanılır - duvara montaj
-------------	--

PİL

Referans Tanım

<b>3507/6</b>	6V 0.5Ah pil - 3550 merkezi ünite
---------------	-----------------------------------



3507/6

BEYAZ

ALÜMİNYUM

ANTRASİT



HD4685



HC4685



HS4685

LOCAL DISPLAY

Referans Tanım

<b>HD4685</b>	OLED teknolojisi ile üretilen dokunmatik ekran ile otomasyon, sıcaklık kontrol ve müzik yayın sistemini kontrol etmek mümkündür
<b>HC4685</b>	
<b>HS4685</b>	

ORTAK ÜRÜNLER



3457

HARİCİ SENSÖR

Referans Tanım

<b>3457</b>	Local Display için harici sensör
-------------	----------------------------------



# MY HOME

## Sıcaklık kontrol



### BEYAZ



HD4693



HD4692



HD4692FAN

### ALÜMİNYUM



HC4693



HC4692



HC4692FAN

### ANTRASİT



HS4693



HS4692



HS4692FAN

### ORTAK ÜRÜNLER



3455

### BEYAZ



HD4577

### ALÜMİNYUM



HC4577

### ANTRASİT



HS4577

### SENSÖRLER

Referans Tanım

**HD4693** Oda ısısını, ısıtma ve soğutma sistemlerini kontrol etmek için  
**HC4693** sensör - ısı derecesi ayar aralığı 3-40°C – iki modül  
**HS4693**

**HD4692** Yukarıdaki gibi - ayarlanan ısı derecesine  $\pm 3^\circ\text{C}$  değişim için  
**HC4692** ve durum seçimi yapılabilir  
**HS4692**

**HD4692FAN** Yukarıdaki gibi - fanlı kalorifer serpantini (fan-coil) ve Idrorelax  
**HC4692FAN** sistemi için manuel/otomatik hız seçimi  
**HS4692FAN**

### RF SICAKLIK SENSÖRÜ

Referans Tanım

**3455** RF harici sıcaklık sensörü - RF alıcı arayüz HD/HC/HS/L/N/NT4577 -  
ile birlikte kullanılır - güneş enerjisi ile beslenir - IP65.

### SENSÖRLER İÇİN RADYO ALICILI ARAYÜZ

Referans Tanım

**HD4577** RF alıcı arayüz - RF harici sıcaklık sensörü ref. 3455 için -  
**HC4577** 27V d.c. besleme - 2 modül  
**HS4577**



F430/2



F430/4

**AKTUATÖRLER**

Referans	Tanım
<b>F430/2</b>	2 bağımsız röleli aktüatör - tek ve çift yükler için 6A resistif, 3A motorlu vana ve pompalar - konfigürasyon ile röle kilidi yapılabilir - 2 DIN modül
<b>F430/4</b>	4 bağımsız röleli aktüatör - tek ve çift veya karışık yükler için: 6A dirençli, 3A motorlu vanalar, pompalar ve fanlı kalorifer serpantini (fan-coil) - konfigürasyon ile röle kilidi yapılabilir - 2 DIN modül



3480



F482

**KONTAK ARAYÜZ MODÜL**

Referans	Tanım
<b>3480</b>	NK elektromanyetik kontak arayüz modülü – dengelenmiş ve dengelenmemiş 2 kontak linye hattına bağlanabilir – hafızalı LED li alarm sinyali.
<b>F482</b>	NK elektromanyetik kontak arayüz modülü – dengelenmiş ve dengelenmemiş 2 kontak linye hattına bağlanabilir – hafızalı LED li alarm sinyali - 2 DIN modül



3510



3510M



3510PB



3511



3513



3512

**MANYETİK KONTAKLAR**

Referans	Tanım
<b>3510</b>	Dedektörler ve koruma linye arasında arayüz görevi gören NK elektromanyetik kontak – sıvaaltı montaja uygundur.
<b>3510M</b>	Yukarıdaki gibi sensör – pirinç malzeme, yüksek mekanik dayanıklılık – ferromanyetik olmayan pencere ve kapı çerçevelerinde kullanılır.
<b>3510PB</b>	Yukarıdaki gibi sensör – pirinç malzeme, yüksek mekanik dayanıklılık – her türlü pencere ve kapı çerçevelerinde ve zırlı kapılarda kullanılır.
<b>3511</b>	Yukarıdaki gibi sensör – görülebilir şekilde montaj için kullanılan tip
<b>3512</b>	Yukarıdaki gibi sensör – döner kapı ve sürgülü kapı düzenleri için dökme alüminyum malzeme. Yere monte edilir.
<b>3513</b>	Yukarıdaki gibi sensör – ana kapıların metal yüzeylerine görülebilir şekilde monte edilir.



F422

**SCS-SCS ARAYÜZ**

Referans	Tanım
<b>F422</b>	Farklı fonksiyonlara sahip BUS sistemleri için arayüz - 2 DIN modül

**SPLIT KLİMA ARAYÜZÜ**

Referans	Tanım
<b>3456</b>	İklimlendirme cihazları için IR verici arayüz - iklimlendirme ünitesi uzaktan kumandasının sinyallerini öğrenir ve üretir. Dokunmatik Ekran ve Multimedya Dokunmatik ekrandan kumanda edilebilir. IR kablo uzunluğu 2m.



F520



3523



3522

### TÜKETİM GÖSTERGESİ

Referans	Tanım
<b>F520</b>	Maksimum 3 devre için elektrik enerjisi sayacı - uygun girişlerine maks. 3 adet toroid bağlanabilir. Toplanmış ve işlenmiş bilgi Dokunmatik Ekran veya Multimedia, Dokunmatik Ekran üzerinden görüntülenebilir - 1 DIN modül.
<b>3523</b>	Ek toroid - kablo uzunluğu 400 mm.
<b>3522</b>	Darbe sayacı - su, gaz, vb. gibi sayaçlardan gelen bilgiyi derler. Ölçülen değerler Dokunmatik Ekran veya Multimedia Dokunmatik Ekran üzerinden görüntülenebilir.



F521



F522



F523

BEYAZ

ALÜMİNYUM

ANTRASİT



HD4672N



HC4672N



HS4672N

### YÜK YÖNETİMİ

Referans	Tanım
<b>F521</b>	Yük yönetim sistemi aktuatörlerinin kontrol edilmesi için merkezi ünite. Merkezi ünite maks. 63 yükü kontrol eder. (3 kW arası +/- 20% toleransla) - 1 DIN modül.
<b>F522</b>	Entegre Akım göstergeli pano tipi aktuatör - kontrol edilebilen yükler: 16A rezistif, 10A akkor lamba ve 4A floresan veya ferromanyetik trafo - ek toroid bağlantısıyla kaçak akım kontrolü - 1 modül.
<b>F523</b>	Pano tipi aktuatör - kontrol edilebilen yükler: 16A rezistif, 10A akkor lamba ve 4A floresan veya ferromanyetik trafo - 1 modül.
<b>HD4672N</b> <b>HC4672N</b> <b>HS4672N</b>	Sıva altı aktuatör - kontrol edilebilen yükler: 16A rezistif, 10A akkor lamba ve 4A floresan veya ferromanyetik trafo - 2 modül.

### AKSESUARLAR

Referans	Tanım
<b>3508BUS</b>	BUS bağlantı fiş klemens - 3.81 mm
<b>3508U2</b>	2 kutup fiş klemens
<b>3508U3</b>	3 kutup fiş klemens

## MY HOME

### Ortak aksesuarlar



E46ADCN



E49



335919



3559

 L4669  
L4669/500

3515



3501/0



3501/1



3501/2



3501/3



3501/4



3501/5



3501/6



3501/7



3501/8



3501/9



3501/GEN



3501/GR



3501/AMB



3501/AUX



3501/ON



3501/OFF



3501/OI



3501/PUL



3501/SLA



3501/CEN



3501/T



3501/TM

### GÜÇ KAYNAKLARI

Referans

Tanım

**E46ADCN** Otomasyon ve sıcaklık kontrol sistemi için güç kaynağı - Besleme 230Vac, çıkış 27Vdc -1.2A - 8 DIN modül

**E49** Otomasyon ve sıcaklık kontrol sistemi için kompakt güç kaynağı - Besleme 230Vac, çıkış 27Vdc - 600 mA - 2 DIN modül.

### PC ARAYÜZ

Referans

Tanım

**335919** Merkezi üniteleri programlamak için seri PC kablo

**3559** Yukarıdaki gibi - USB port bağlantılı

### KABLO

Referans

Tanım

**L4669** Ekranız SCS otomasyon sistemleri için 2 li esnek kablo - yalıtım 300/500V - CEI 46-5 ve CEI 20-20 standartları ile uyumludur - 100 metre

**L4669/500** Yukarıdaki gibi 500m

### KLEMENS

Referans

Tanım

**3515** Yedek klemens

### KONFIGÜRATÖRLER

Referans

Tanım

**3501/0** Konfigüratör 0

**3501/1** Konfigüratör 1

**3501/2** Konfigüratör 2

**3501/3** Konfigüratör 3

**3501/4** Konfigüratör 4

**3501/5** Konfigüratör 5

**3501/6** Konfigüratör 6

**3501/7** Konfigüratör 7

**3501/8** Konfigüratör 8

**3501/9** Konfigüratör 9

**3501/GEN** Konfigüratör GEN

**3501/GR** Konfigüratör GR

**3501/AMB** Konfigüratör AMB

**3501/AUX** Konfigüratör AUX

**3501/ON** Konfigüratör ON

**3501/OFF** Konfigüratör OFF

**3501/OI** Konfigüratör OI

**3501/PUL** Konfigüratör PUL

**3501/SLA** Konfigüratör SLA

**3501/CEN** Konfigüratör CEN

**3501/T** Konfigüratör ↑↓

**3501/TM** Konfigüratör ↑↓ M

# MY HOME

## Aksesuarlar



3501K



3501K/1

### KONFIGÜRATÖR KİT

Referans	Tanım
<b>3501K</b>	Konfigüratör kit (0 - 9)
<b>3501K/1</b>	Konfigüratör kit AUX, GEN, GR, AMB,ON, OFF, O/I, PUL, SLA, CEN, ↑↓ ↑↓, M

### SANAL KONFIGÜRASYON CİHAZI

Referans	Tanım
<b>3503N</b>	Otomasyon sisteminin el bilgisayarı ve SANAL KONFIGÜRASYON yazılımı kullanılarak konfigüre edilmesini sağlar.



3503N

**İÇİNDEKİLER****AXOLUTE GÖRÜNTÜLÜ İTERKOM SİSTEMİ**

Görüntülü iç üniteler - ev otomasyon sistemi \_\_\_\_\_ 122

Axolute Outdoor \_\_\_\_\_ 123





# GÖRÜNTÜLÜ İÇ ÜNİTELER EV OTOMASYON SİSTEMİ

## BEYAZ



349313

## ALÜMİNYUM



349311

## ANTRASİT



349312

## VIDEO DISPLAY

Referans Tanım

**349313** 2 kablolu video sistemlere monte edilebilen eller serberst (handsfree),  
**349311** 2.5" LCD ekranlı dahili ünite. PC üzerinden programlanabilen  
**349312** menüsü sayesinde MY HOME sistemleri ile kombine edilebilir;  
interkom, iklimlendirme, müzik yayın, senaryo ve alarm sistemlerini  
kumanda eder. Navigasyon, otomatik açma, kapı kilidi  
açma, eller serbest konuşma ve menü için ileri ve geri tuşları mevcut.  
Bağlantı, kapı kilidi ve çağrının durumu LED'ler ile gösterilir.  
Konfigürasyon konfigüratörler ya da USB port ile PC üzerinden yapılır.  
506E buatına yerleştirilerek, siva altı montaj yapılır. 506E kasaya uygun  
her türlü AXOLUTE çerçevesi ile uyumludur.

## WHICE



349321

## NIGHTER



349320

## NIGHTER & WHICE VIDEO STATION

Referans Tanım

**349321** 2 kablolu sistemlerde Stereo hoparlörü olarak kullanılabilir.  
**349320** 8" renkli LCD ekran. MY HOME sistemiyle entegre edilebilen cihaz  
bilgisayar üzerinden kişiselleştirilebilen menüsüyle; görüntülü kapı  
giriş sistemini, sıcaklık kontrol sistemini, HI-FI stereo  
ses sistemini, senaryoları, alarmları, yönetebilmektedir. HI-FI ses  
sistemiyle entegre edilmiş sistemlerde video station sistemde mevcut  
ses sinyallerini çalmayı sağlayan bir amfifikatör gibi çalışır. Menü  
ilerleme tuşları, otomatik açılma, kapı kilidi, merdiven otomatiği,  
sessiz, hoparlör bağlantısı. İkaz LEDi : çağrı sonlandırma, kapı durumu,  
multimedia arayüzle bağlantı. Konfigüratörlerle ve menü üzerinden  
kofiğüre edilebilir. USB ve RS232 PORT ile bilgisayardan konfigüre  
edilenilir.

## ORTAK ÜRÜNLER

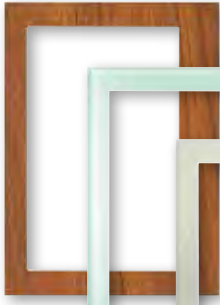

349212

349211

349210



349310

## VIDEO STATION

Referans Tanım

**349310** 2 kablolu video sistemlere monte edilebilen stereo eller serberst 5.6" LCD  
ekranlı dahili ünite. PC üzerinden programlanabilen menüsü sayesinde  
MY HOME sistemleri ile kombine edilebilir; interkom, iklimlendirme,  
müzik yayın, senaryo ve alarm sistemlerini kumanda eder. Müzik yayın  
sisteminde, Video Station amfifikatör görevi üstlenir ve sistemdeki  
tüm ses kaynaklarını yönetir. Navigasyon, otomatik açma, kapı kilidi  
açma, merdiven ışığı, sessiz mod, eller serbest konuşma ve menü için  
ileri ve geri tuşları mevcuttur. Bağlantı, kapı kilidi ve çağrının durumu  
LED'ler ile gösterilir. Konfigürasyon konfigüratörler ya da USB ve RS232  
port ile PC üzerinden yapılır. Özel montaj plakası ve kancası ile siva üstü  
montaj yapılır. Cam, ahşap ve alüminyum olmak üzere üç özel çerçevesi  
tamamlanır.

## VIDEO STATION İÇİN ÇERÇEVELER

Referans Tanım

**349210** Satine alüminyum çerçeve

**349211** KRİSTALL cam çerçeve

**349212** TiK ağacı çerçeve

## BEYAZ



391663

## ALÜMİNYUM



391661

## ANTRASİT



391662

## 2 KABLULU DAHİLİ KAMERALAR

Referans Tanım

**391663** Siva altı -mikrofonlu- 1.3" CCD, 3.7 mm lensli

**391661** 2 kablolu renkli kamera

**391662**

# AXOLUTE OUTDOOR



## OUTDOOR

Referans	Tanım
<b>339313</b>	Çelik yırtılma dayanımlı siva altı kasa – 3 modül
<b>349140</b>	Elektronik modül hoparlör, mikrofon modülü, motorlu kamera ve renkli ekran. Giriş kontrol için entegre proximity okuyucu. Programlama ve konfigürasyon yazılımı
<b>339213</b>	3 modül çelik çerçeve + kaide. Montaj ve demontaj için özel anahtar.
<b>339223</b>	3 modül pirinç çerçeve + kaide. Montaj ve demontaj için özel anahtar.



348402



348200 - 348201 - 348202 - 348203  
- 348204 - 348205 - 348206

## PROGRAMLAYICI VE TRANSPONDER KART

Referans	Tanım
<b>348402</b>	Transponder kart programlayıcı
<b>348200</b>	Siyah transponder kart
<b>348201</b>	Kırmızı transponder kart
<b>348202</b>	Yeşil transponder kart
<b>348203</b>	Mavi transponder kart
<b>348204</b>	Turuncu transponder kart
<b>348205</b>	Gri transponder kart
<b>348206</b>	Sarı transponder kart

Duvardan minimum koruma

### Kolay bakım ve çalınmaya

karşı koruma için çerçeveler özel bir anahtarla sabitlenir.

Çelik çerçeve için 11 mm  
Pirinç çerçeve için 13,5 mm



Kurulum çelik yırtılma dayanımlı siva altı kasa kullanılmasıyla sorunsuz olacaktır. 3 modül SFERA kasaya montaj yapılabilir.  
koruma indeksi : IP54  
mekanik darbeye karşı koruma indeksi : IK07

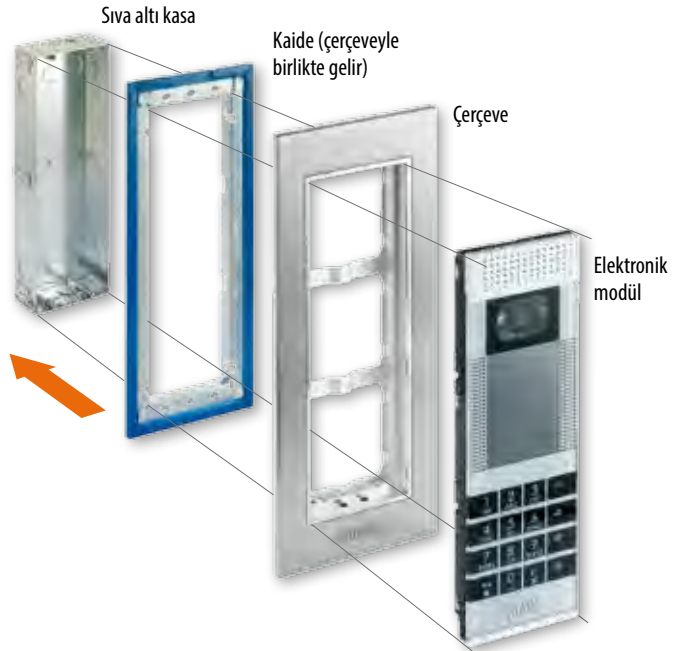



**İÇİNDEKİLER****ÇERÇEVELER: KURULUM VE RENKLER**

Montaj ve seçim tablosu .....	126
Dikdörtgen çerçeveler .....	138
Eliptik çerçeveler .....	142



# ALMAN VE FRANSIZ STANDARTI MONTAJ

Buatlar



502E (vidalı)  
(70x70x50)

Kaideler



H4702G (tırnaklı)



H4702 (vidalı)

Modül sayısı



2 modül

Çerçeveler



HA4802..



HB4802...

**YATAY KURULUM**  
**MERKEZLER ARASI 71 MM**

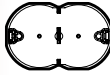

2 x 502E (vidalı) (70x70x50)



H4702G (tırnaklı)



H4702 (vidalı)



2 + 2 modül



HA4802M2H...



HB4802/2...  
HB4802M2...

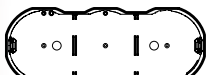

3 x 502E (vidalı) (70x70x50)



H4702G (tırnaklı)



H4702 (vidalı)



2 + 2 + 2 modül



HA4802M3H...



HB4802/3...  
HB4802M3...



4 x 502E (vidalı) (70x70x50)



H4702G (tırnaklı)



H4702 (vidalı)



2 + 2 + 2 + 2 modül



HA4802M4H...



HB4802/4...  
HB4802M4...

**NOT:** Kaideler turuncu kaide koruyucusu ve şefak mekanizma koruyucusu ile temin edilir. Koruyucu plakaların çerçeveler takılmadan çıkarılmaması önerilir.

Buatlar

Kaideler

Modül sayısı

Çerçeveler

**DİKEY KURULUM**  
**MERKEZLER ARASI 71 MM**

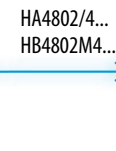
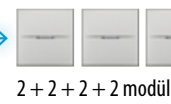
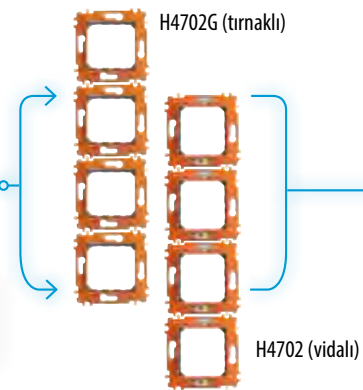
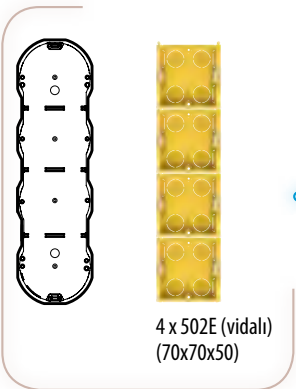
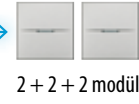
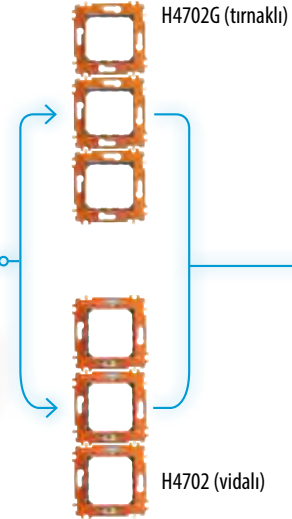
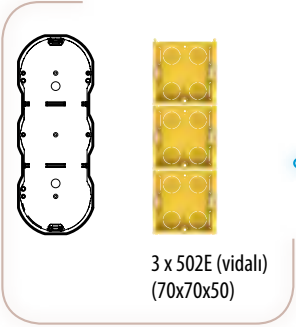
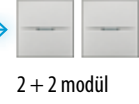
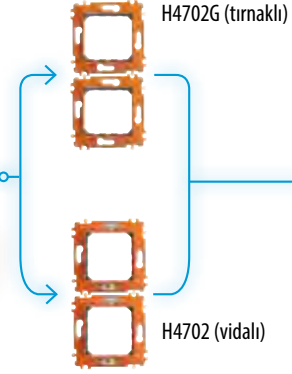

**NOT:** Kaideler turuncu kaide koruyucusu ve şefaf mekanizma koruyucusu ile temin edilir. Koruyucu plakaların çerçeveler takılmadan çıkarılmaması önerilir.





# ALMAN STANDARTI ELİPTİK ÇERÇEVELER: SEÇİM TABLOSU

## MODÜLLER

	2	2+2	2+2+2	2+2+2+2
		merkezler arası 71mm	merkezler arası 71mm	merkezler arası 71mm

## ELİPTİK ÇERÇEVELER

METAL					
	Axolute alüminyum	HB4802XC	HB4802/2XC	HB4802/3XC	HB4802/4XC
	Axolute antrasit	HB4802XS	HB4802/2XS	HB4802/3XS	HB4802/4XS
	masif siyah	HB4802NR	HB4802/2NR	HB4802/3NR	HB4802/4NR
LİKİT					
	likit beyaz	HB4802DB	HB4802/2DB	HB4802/3DB	HB4802/4DB
	likit fildişi	HB4802DA	HB4802/2DA	HB4802/3DA	HB4802/4DA
	likit mavi	HB4802DZ	HB4802/2DZ	HB4802/3DZ	HB4802/4DZ
	likit turuncu	HB4802DR	HB4802/2DR	HB4802/3DR	HB4802/4DR
	likit yeşil	HB4802DV	HB4802/2DV	HB4802/3DV	HB4802/4DV
PARLAK					
	parlak altın	HB4802OR	HB4802/2OR	HB4802/3OR	HB4802/4OR
	açık titanyum	HB4802TC	HB4802/2TC	HB4802/3TC	HB4802/4TC
	mat gümüş	HB4802SA	HB4802/2SA	HB4802/3SA	HB4802/4SA
	mat altın	HB4802OS	HB4802/2OS	HB4802/3OS	HB4802/4OS
AHŞAP					
	akçaağaç	HB4802LAE	HB4802/2LAE	HB4802/3LAE	HB4802/4LAE
	kiraz	HB4802LCA	HB4802/2LCA	HB4802/3LCA	HB4802/4LCA
	ceviz	HB4802LNC	HB4802/2LNC	HB4802/3LNC	HB4802/4LNC
ÇELİK					
	parlak Alessi paslanmaz çelik	HB4802AXL			
	satine Alessi paslanmaz çelik	HB4802AXS			
	parlak çelik	HB4802ACL	HB4802/2ACL	HB4802/3ACL	HB4802/4ACL
	satine çelik	HB4802ACS	HB4802/2ACS	HB4802/3ACS	HB4802/4ACS
DERİ					
	kum deri	HB4802SLC	HB4802/2SLC	HB4802/3SLC	HB4802/4SLC
	kahve deri	HB4802SLS	HB4802/2SLS	HB4802/3SLS	HB4802/4SLS
BEYAZ					
	AXOLUTE BEYAZ	HB4802HD	HB4802M2HD	HB4802M3HD	HB4802M4HD
	Corian® BEYAZ	HB4802CGW	HB4802M2CGW	HB4802M3CGW	HB4802M4CGW

## KAİDELER

vidalı tırnaklı	H4702 H4702G	H4702 (x2) H4702G (x2)	H4702 (x3) H4702G (x3)	H4702 (x4) H4702G (x4)
eliptik çerçeveler için LED'li kaide	HB4702X			

# ALMAN STANDARTI DİKDÖRTGEN ÇERÇEVELER: SEÇİM TABLOSU

## MODÜLLER

YATAY			
2	2+2	2+2+2	
	merkezler arası 71mm	merkezler arası 71mm	

## DİKDÖRTGEN ÇERÇEVELER

ALÜMİNYUM				
	satine alüminyum	HA4802XC	HA4802/2XC	HA4802/3XC
	satine antrasit	HA4802XS	HA4802/2XS	HA4802/3XS
	satine titanyum	HA4802NX	HA4802/2NX	HA4802/3NX
LAKE				
	Limoges beyazı	HA4802BG	HA4802/2BG	HA4802/3BG
	Çin kırmızısı	HA4802RC	HA4802/2RC	HA4802/3RC
	Sevres yeşili	HA4802VS	HA4802/2VS	HA4802/3VS
	Meissen mavisi	HA4802BM	HA4802/2BM	HA4802/3BM
ANODİZE				
	satine krom	HA4802CR	HA4802/2CR	HA4802/3CR
	satine bronz	HA4802BR	HA4802/2BR	HA4802/3BR
	satine civa	HA4802AZ	HA4802/2AZ	HA4802/3AZ
	mat gümüş	HA4802SA	HA4802/2SA	HA4802/3SA
AHSAP				
	dişbudak	HA4802LFR	HA4802/2LFR	HA4802/3LFR
	tik	HA4802LTK	HA4802/2LTK	HA4802/3LTK
	wenge	HA4802LWE	HA4802/2LWE	HA4802/3LWE
CAM				
	siyah cam	HA4802VNN	HA4802/2VNN	HA4802/3VNN
	mavi cam	HA4802VZS	HA4802/2VZS	HA4802/3VZS
	ayna cam	HA4802VSA	HA4802/2VSA	HA4802/3VSA
	kristal cam	HA4802VKA	HA4802/2VKA	HA4802/3VKA
TAŞ				
	arduaz	HA4802RLV	HA4802/2RLV	HA4802/3RLV
	Carrara mermeri	HA4802RMC	HA4802/2RMC	HA4802/3RMC
BEYAZ				
	AXOLUTE BEYAZ	HA4802HD	HA4802M2HD	HA4802M3HD
	BEYAZ cam	HA4802VBB	HA4802M2VBB	HA4802M3VBB
NIGHTER & WHICE				
	Nighter	HA4802VNB	HA4802M2VNB	HA4802M3VNB
	Whice	HA4802VSW	HA4802M2VSW	HA4802M3VSW

## KAİDELER

vidalı	H4702	H4702 (x2)	H4702 (x3)
tırnaklı	H4702G	H4702G (x2)	H4702G (x3)
eliptik çerçeveler için LED'li kaide	HA4702X		

## DIKEY

2+2+2+2 merkezler arası 71mm	2+2 merkezler arası 71mm	2+2+2 merkezler arası 71mm	2+2+2+2 merkezler arası 71mm
HA4802/4XC	HA4802/2XC	HA4802/3XC	HA4802/4XC
HA4802/4XS	HA4802/2XS	HA4802/3XS	HA4802/4XS
HA4802/4NX	HA4802/2NX	HA4802/3NX	HA4802/4NX
HA4802/4BG	HA4802/2BG	HA4802/3BG	HA4802/4BG
HA4802/4RC	HA4802/2RC	HA4802/3RC	HA4802/4RC
HA4802/4VS	HA4802/2VS	HA4802/3VS	HA4802/4VS
HA4802/4BM	HA4802/2BM	HA4802/3BM	HA4802/4BM
HA4802/4CR	HA4802/2CR	HA4802/3CR	HA4802/4CR
HA4802/4BR	HA4802/2BR	HA4802/3BR	HA4802/4BR
HA4802/4AZ	HA4802/2AZ	HA4802/3AZ	HA4802/4AZ
HA4802/4SA	HA4802/2SA	HA4802/3SA	HA4802/4SA
HA4802/4LFR	HA4802/2LFR	HA4802/3LFR	HA4802/4LFR
HA4802/4LTK	HA4802/2LTK	HA4802/3LTK	HA4802/4LTK
HA4802/4LWE	HA4802/2LWE	HA4802/3LWE	HA4802/4LWE
HA4802/4VNN	HA4802/2VNN	HA4802/3VNN	HA4802/4VNN
HA4802/4VZS	HA4802/2VZS	HA4802/3VZS	HA4802/4VZS
HA4802/4VSA	HA4802/2VSA	HA4802/3VSA	HA4802/4VSA
HA4802/4VKA	HA4802/2VKA	HA4802/3VKA	HA4802/4VKA
HA4802/4RLV	HA4802/2RLV	HA4802/3RLV	HA4802/4RLV
HA4802/4RMC	HA4802/2RMC	HA4802/3RMC	HA4802/4RMC
HA4802M4HD	HA4802M2HD	HA4802M3HD	HA4802M4HD
HA4802M4VBB	HA4802M2VBB	HA4802M3VBB	HA4802M4VBB
HA4802M4VNB	HA4802M2VNB	HA4802M3VNB	HA4802M4VNB
HA4802M4VSW	HA4802M2VSW	HA4802M3VSW	HA4802M4VSW

H4702 (x4)

H4702G (x4)

# İTALYAN STANDARTI MONTAJ

## Buatlar



500  
(Ø 60x44 mm)  
sıva altı

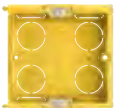

502E  
(70x70x50)



PB502  
(Ø 68x51 mm)  
alçıpan

## Kaideler



H4702 (tırnaklı)

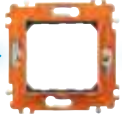

H4702 vidalı

## Modül sayısı

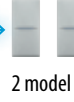

2 model

## Çerçeveler



HA4802...

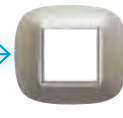

HB4802...



503E  
(108x74x53.5 mm)  
sıva



PB503  
(109x68x51 mm)  
alçıpan



H4703 vidalı



3 modül



HA4803...



HB4803...



504E  
(133x74x53.5 mm)  
sıva altı



PB504  
(131.5x68x51 mm)  
alçıpan



H4704 vidalı



4 modül



HA4804...



HB4804...

**NOT:** kaideler turuncu kaide koruyucusu ve şeffaf mekanizma koruyucusu ile birlikte temin edilir. Koruyucu plakaları çerçeveler takılmadan çıkarılması önerilir.

## Buatlar



506L  
(183.5x90x53.5 mm)  
sıva altı



PB506  
(182x68x51 mm)  
alçıpan

## Kaideler



H4706 vidalı

## Modül sayısı



6 modül

## Çerçeveler



HA4806...



HB4806...

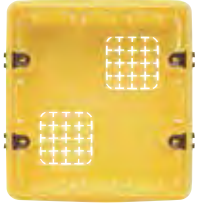

506E  
(108x118x51.5 mm)  
sıva altı



PB526  
(109x114x51 mm)  
alçıpan

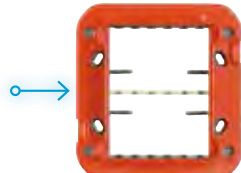

H4726 vidalı

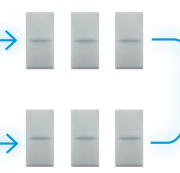

3 + 3 modül



HA4826...



HB4826...



# İTALYAN STANDARTI DİKDÖRTGEN ÇERÇEVELER: SEÇİM TABLOSU

## MODÜLLER





	2	3	4	6	3 + 3
--	---	---	---	---	-------

## DİKDÖRTGEN ÇERÇEVELER





### ALÜMİNYUM

	satine alüminyum	HA4802XC	HA4803XC	HA4804XC	HA4806XC	HA4826XC
	satine antrasit	HA4802XS	HA4803XS	HA4804XS	HA4806XS	HA4826XS
	satine titanyum	HA4802NX	HA4803NX	HA4804NX	HA4806NX	HA4826NX

### LAK

	Limoges beyazı	HA4802BG	HA4803BG	HA4804BG	HA4806BG	HA4826BG
	Çin kırmızısı	HA4802RC	HA4803RC	HA4804RC	HA4806RC	HA4826RC
	Sevres yeşili	HA4802VS	HA4803VS	HA4804VS	HA4806VS	HA4826VS
	Meissen mavisi	HA4802BM	HA4803BM	HA4804BM	HA4806BM	HA4826BM



### ANODİZE

	satine krom	HA4802CR	HA4803CR	HA4804CR	HA4806CR	HA4826CR
	satine bronz	HA4802BR	HA4803BR	HA4804BR	HA4806BR	HA4826BR
	satine civa	HA4802AZ	HA4803AZ	HA4804AZ	HA4806AZ	HA4826AZ
	mat gümüş	HA4802SA	HA4803SA	HA4804SA	HA4806SA	HA4826SA

### AHŞAP

	dişbudak	HA4802LFR	HA4803LFR	HA4804LFR	HA4806LFR	HA4826LFR
	tik	HA4802LTK	HA4803LTK	HA4804LTK	HA4806LTK	HA4826LTK
	wenge	HA4802LWE	HA4803LWE	HA4804LWE	HA4806LWE	HA4826LWE

### CAM

	siyah cam	HA4802VNN	HA4803VNN	HA4804VNN	HA4806VNN	HA4826VNN
	mavi cam	HA4802VZS	HA4803VZS	HA4804VZS	HA4806VZS	HA4826VZS
	ayna cam	HA4802VSA	HA4803VSA	HA4804VSA	HA4806VSA	HA4826VSA
	kristal cam	HA4802VKA	HA4803VKA	HA4804VKA	HA4806VKA	HA4826VKA

### TAŞ

	arduaz	HA4802RLV	HA4803RLV	HA4804RLV	HA4806RLV	HA4826RLV
	Carrara mermeri	HA4802RMC	HA4803RMC	HA4804RMC	HA4806RMC	HA4826RMC

### BEYAZ

	AXOLUTE beyaz	HA4802HD	HA4803HD	HA4804HD	HA4806HD	HA4826HD
	beyaz cam	HA4802VBB	HA4803VBB	HA4804VBB	HA4806VBB	HA4826VBB

### NIGHTER & WHICE

	Nighter	HA4802VNB	HA4803VNB	HA4804VNB	HA4806VNB	HA4826VNB
	Whice	HA4802VSW	HA4803VSW	HA4804VSW	HA4806VSW	HA4826VSW

## KAİDELER



vidalı	H4702	H4703	H4704	H4706	H4726
tırmaklı	H4702G				
dikdörtgen çerçeveler için LED'li kaideler	HA4702X	HA4703X	HA4704X		

# İTALYAN STANDARDI ELİPTİK ÇERÇEVELER: SEÇİM TABLOSU





**MODÜLER**

2 3 4 6 3+3

**ELİPTİK ÇERÇEVELER**
**METAL**

	Axolute alüminyum	HB4802XC	HB4803XC	HB4804XC	HB4806XC	HB4826XC
	Axolute antrasit	HB4802XS	HB4803XS	HB4804XS	HB4806XS	HB4826XS
	masif siyah	HB4802NR	HB4803NR	HB4804NR	HB4806NR	HB4826NR

**LİKİT**

	likit beyaz	HB4802DB	HB4803DB	HB4804DB	HB4806DB	HB4826DB
	likit fildişi	HB4802DA	HB4803DA	HB4804DA	HB4806DA	HB4826DA
	likit mavi	HB4802DZ	HB4803DZ	HB4804DZ	HB4806DZ	HB4826DZ
	likit turuncu	HB4802DR	HB4803DR	HB4804DR	HB4806DR	HB4826DR
	likit yeşil	HB4802DV	HB4803DV	HB4804DV	HB4806DV	HB4826DV



**PARLAK**

	parlak altın	HB4802OR	HB4803OR	HB4804OR	HB4806OR	HB4826OR
	açık titanyum	HB4802TC	HB4803TC	HB4804TC	HB4806TC	HB4826TC
	mat gümüş	HB4802SA	HB4803SA	HB4804SA	HB4806SA	HB4826SA
	mat altın	HB4802OS	HB4803OS	HB4804OS	HB4806OS	HB4826OS



**AHŞAP**

	akçaağaç	HB4802LAE	HB4803LAE	HB4804LAE	HB4806LAE	HB4826LAE
	kiraz	HB4802LCA	HB4803LCA	HB4804LCA	HB4806LCA	HB4826LCA
	ceviz	HB4802LNC	HB4803LNC	HB4804LNC	HB4806LNC	HB4826LNC

**ÇELİK**

	parlak Alessi paslanmaz çelik	HB4802AXL	HB4803AXL	HB4804AXL	HB4806AXL	HB4826AXL
	satine Alessi paslanmaz çelik	HB4802AXS	HB4803AXS	HB4804AXS	HB4806AXS	HB4826AXS

**DERİ**

	kum deri	HB4802SLC	HB4803SLC	HB4804SLC	HB4806SLC	HB4826SLC
	kahve deri	HB4802SLS	HB4803SLS	HB4804SLS	HB4806SLS	HB4826SLS

**BEYAZ**

	AXOLUTE beyaz	HB4802HD	HB4803HD	HB4804HD	HB4806HD	HB4826HD
	Corian® Glacier beyaz	HB4802CGW	HB4803CGW	HB4804CGW	HB4806CGW	HB4826CGW

**KAİDELER**

vidalı	H4702	H4703	H4704	H4706	H4726
tırmaklı	H4702G				
Elıptık çerçeveller için LED'li kaideler	HB4702X	HB4703X	HB4704X		

# NIGHTER-WHICE VE CAM ANAHTARLAR, DOKUNMATİK EKРАН VE VİDEO DISPLAY - MONTAJI

## Buatlar



503E  
(108x74x53.5 mm)  
sıva altı



PB503  
(109x68x51 mm) alçıpan

## Kaideler



H4703 vidalı bağlantı  
83.5mm mesafe

## Modül sayısı



HC4657M3 - HD4657M3



HS4657M3

## Çerçeveler



504E  
(133x74x53.5 mm)  
sıva altı



PB504  
(131.5x68x51 mm) alçıpan



H4704 vidalı bağlantı  
108.5mm mesafe



HC4657M4 - HD4657M4



HS4657M4



506E  
(108x118x51.5 mm)  
sıva altı



PB526  
(109x114x51 mm)  
alçıpan

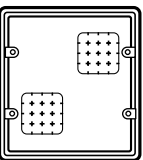

H4684



349313



349311



349312



HA4826...



HB4826...

# DOKUNMATİK EKРАН VE VİDEO DISPLAY ÇERÇEVELERİ: SEÇİM TABLOSU

**REFERANSLAR**



H4684
349311
349312
349313

**REFERANSLAR**





H4684
349311
349312
349313

## DİKDÖRTGEN ÇERÇEVELER





**ALÜMİNYUM**

	satine alüminyum	HA4826XC
	satine antrasit	HA4826XS
	satine titanyum	HA4826NX

**LAK**

	Limoges beyazı	HA4826BG
	Çin kırmızısı	HA4826RC
	Sevres yeşili	HA4826VS
	Meissen mavisi	HA4826BM





**ANODİZE**

	satine krom	HA4826CR
	satine bronz	HA4826BR
	satine civa	HA4826AZ
	mat gümüş	HA4826SA

**AHŞAP**

	dişbudak	HA4826LFR
	tik	HA4826LTK
	wenge	HA4826LWE

**CAM**

	siyah cam	HA4826VNN
	mavi cam	HA4826VZS
	ayna cam	HA4826VSA
	kristal cam	HA4826VKA



**TAŞ**

	arduaz	HA4826RLV
	Carrara mermeri	HA4826RMC

**BEYAZ**

	AXOLUTE beyaz	HA4826HD
	beyaz cam	HA4826VBB

**NIGHTER & WHICE**

	Nighter	HA4826VNB
	Whice	HA4826VSW

## ELİPTİK ÇERÇEVELER





**METAL**

	Axolute alüminyum	HB4826XC
	Axolute antrasit	HB4826XS
	masif siyah	HB4826NR

**LİKİT**

	likit beyaz	HB4826DB
	likit fildişi	HB4826DA
	likit mavi	HB4826DZ
	likit turuncu	HB4826DR
	likit yeşil	HB4826DV

**PARLAK**

	parlak altın	HB4826OR
	açık titanyum	HB4826TC
	mat gümüş	HB4826SA
	mat altın	HB4826OS

**AHŞAP**

	akçaağaç	HB4826LAE
	kiraz	HB4826LCA
	ceviz	HB4826LNC



**ÇELİK**

	parlak Alessi çelik	HB4826AXL
	satine Alessi çelik	HB4826AXS
	parlak çelik	HB4826ACL
	satine çelik	HB4826ACS

**DERİ**

	kum deri	HB4826SLC
	kahve deri	HB4826SLS

**BEYAZ**

	AXOLUTE beyaz	HB4826HD
	Corian® Glacier beyaz	HB4826CGW

## DİKDÖRTGEN ÇERÇEVELER (2 MODÜL)

### ALÜMİNYUM



Satine alüminyum - XC



Satine antrasit - XS



Satine titanyum - NX

### LAK



Limoges beyazı - BG



Çin kırmızısı - RC



Meissen Mavisi - BM



Sèvres yeşili - VS

### ANODİZE



Satine krom - CR



Satine bronz - BR



Satine civa - AZ



Gümüş - SA

## DİKDÖRTGEN ÇERÇEVELER (2 MODÜL) DOĞAL ELEMENTLER

### AHŞAP



*Dişbudak - LFR*



*Tik - LTK*



*Wenge - LWE*

### CAM



*Siyah cam - VNN*



*Mavi cam - VZS*



*Kristal cam - VKA*



*Ayna cam - VSA*

### NIGHTER & WHICE



*Nighter - VNB*



*Whice - VSW*

### TAŞ



*Arduaz - RLV*



*Carrara mermeri - RMC*

### BEYAZ



*AXOLUTE beyaz - HD*



*Beyaz cam - VBB*

**AHŞAP VE TAŞ ÇERÇEVELER İÇİN NOT:** Bu çerçeveler 100% doğa maddelerden üretilmiştir, bu sebeple çerçeveler arası küçük renk farklılıklarına rastlanabilir.



# DİKDÖRTGEN ÇERÇEVELER (3 MODÜL)

## ALÜMİNYUM



*Satine alüminyum - XC*



*Satine antrasit - XS*



*Satine titanyum - NX*

## LAK



*Limoges beyazı - BG*



*Çin kırmızısı - RC*



*Meissen mavisi - BM*



*Sèvres yeşili - VS*

## ANODİZE



*Satine krom - CR*



*Satine bronz - BR*



*Satine civa - AZ*



*Gümüş - SA*

## DİKDÖRTGEN ÇERÇEVELER (3 MODÜL) DOĞAL ELEMENTLER

### AHŞAP



*Dişbudak - LFR*



*Tik - LTK*



*Wenge - LWE*

### CAM



*Siyah cam - VNN*



*Mavi cam - VZS*



*Kristal cam - VKA*



*Ayna cam - VSA*

### NIGHTER & WHICE



*Nighter - VNB*



*Whice - VSW*

### TAŞ



*Arduaz - RLV*



*Carrara mermeri - RMC*

**AHŞAP VE TAŞ ÇERÇEVELER İÇİN NOT:** Bu çerçeveler 100%100 doğal maddelerden üretilmiştir, bu sebeple çerçeveler arası küçük renk farklılıklarına rastlanılabilir.

### BEYAZ



*AXOLUTE beyaz - HD*



*Beyaz cam - VBB*

## ELİPTİK ÇERÇEVELER (2 MODÜL)

### METAL



*Axolute alüminyum - XC*



*Axolute antrasit - XS*



*Masif siyah - NR*

### LİKİT



*Likit beyaz - DB*



*Likit fildişi - DA*



*Likit mavi - DZ*



*Likit turuncu - DR*



*Likit yeşil - DV*

### PARLAK



*Parlak altın - OR*



*Mat gümüş - SA*



*Açık titanyum - TC*



*Mat altın - OS*

## ELİPTİK ÇERÇEVELER (2 MODÜL) DOĞAL MALZEMELER

### AHŞAP



Akağaç - LAE



Kiraz - LCA



Ceviz - LNC

### ALESSI STEEL



Alessi® parlak  
çelik - AXL



Alessi® satine  
çelik - AXS



Parlak çelik - ACL



Satine çelik - ACS

### DERİ



Kum deri - SLC



Kahve deri - SLS

### BEYAZ



AXOLUTE beyaz - HD



Corian® Glacier beyaz - CGW

**AHŞAP VE DERİ ÇERÇEVELER İÇİN NOTLAR:** Bu çerçeveler 100% doğal maddelerden üretilmiştir, bu sebeple çerçeveler arası küçük renk farklılıklarına rastlanabilir.

Corian® bir DuPont™ tescilli markasıdır.

Alessi® tescilli markadır.

## ELİPTİK ÇERÇEVELER (3 MODÜL)

### METAL



Alüminyum - XC



Axolute antrasit - XS



Masif siyah - NR

### LİKİT



Likit beyaz - DB



Likit fildişi - DA



Likit mavi - DZ



Likit turuncu - DR



Likit yeşil - DV

### PARLAK



Parlak altın - OR



Mat gümüş - SA



Açık titanyum - TC



Mat altın - OS

## ELİPTİK ÇERÇEVELER (2 MODÜL) DOĞAL MALZEMELER

### AHŞAP



Akağaç - LAE



Kiraz - LCA



Ceviz - LNC

### ALESSI STEEL



Alessi® parlak çelik - AXL



Alessi® satine çelik - AXS

### DERİ



Kum deri - SLC



Kahve deri - SLS

### BEYAZ



AXOLUTE beyaz - HD

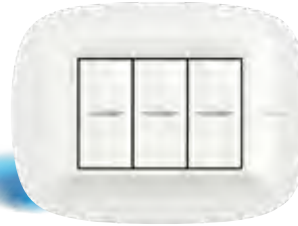

Corian® Glacier beyaz - CGW

**AHŞAP VE DERİ ÇERÇEVELER İÇİN NOTLAR:** Bu çerçeveler 100% doğal maddelerden üretilmiştir, bu sebeple çerçeveler arası küçük renk farklılıklarına rastlanabilir.

Corian® bir DuPont™ tescilli markasıdır.

Alessi® tescilli bir markadır.



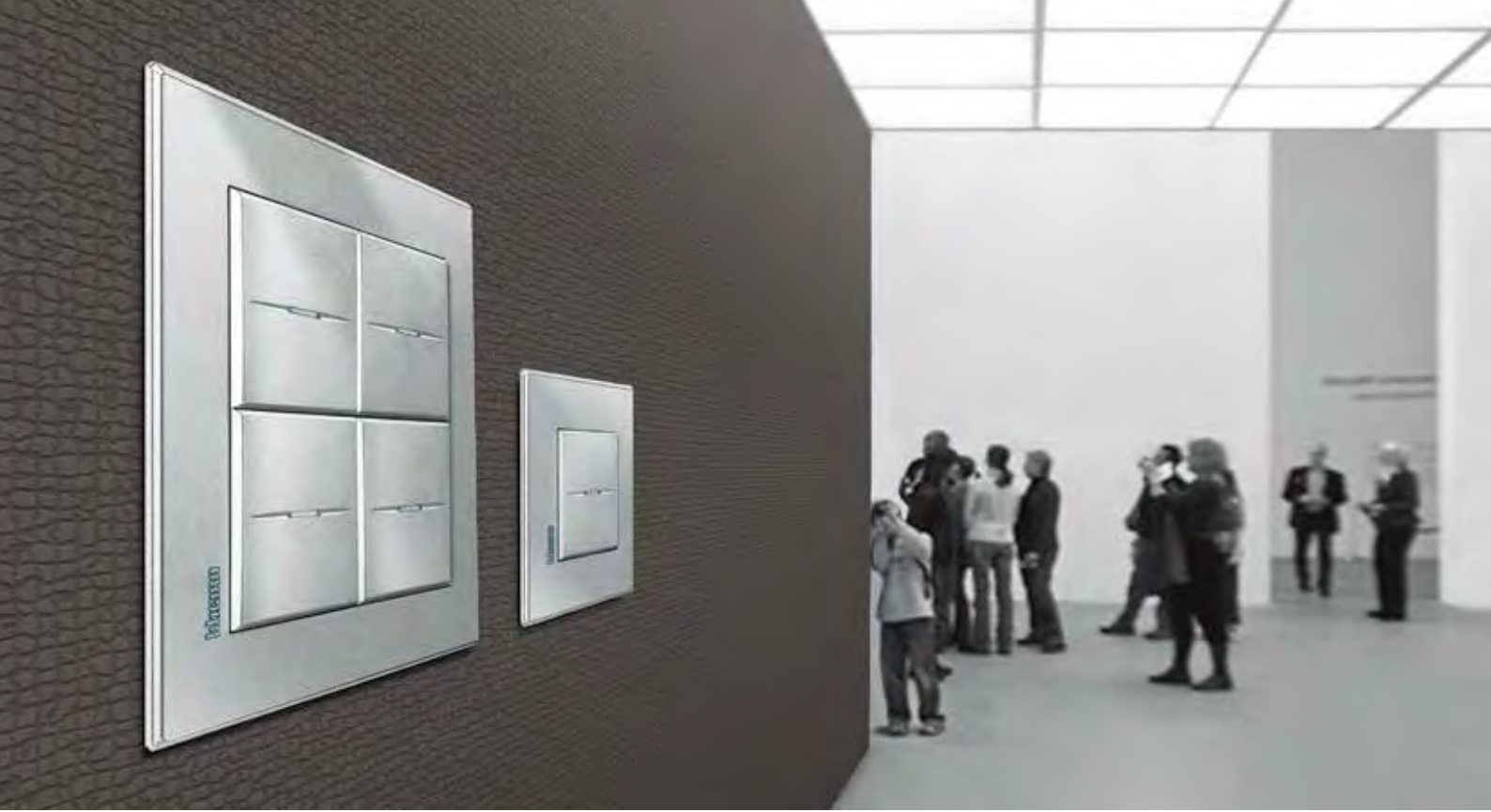

## İÇİNDEKİLER

## AXOLUTE ETÈRIS

Özel montaj sistemi .....	148
Yeni buatlar .....	149
Yeni kaideler .....	150
Yeni çerçeveler .....	151
Montaj prosedürleri .....	152
2 modül buatlar - modülerlik .....	155

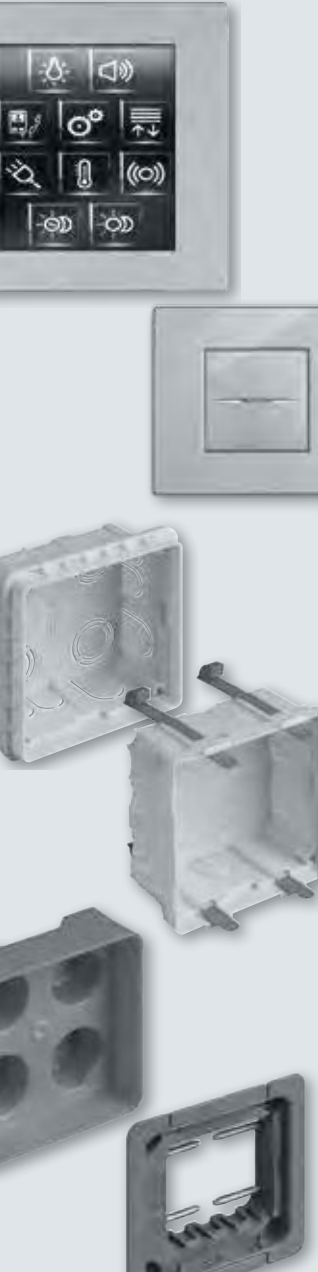

# AXOLUTE ETÈRIS: ÖZEL MONTAJ SİSTEMİ

## YENİ spesifik parçalar:

- yeni sıva altı ve alçıpan **buatlar**
- yeni **kaideler**
- yeni **çerçeveler**

çeşitli uygulama adımlarının tamamlanması için yeni aksesuarlarla birlikte kullanılmaktadır.

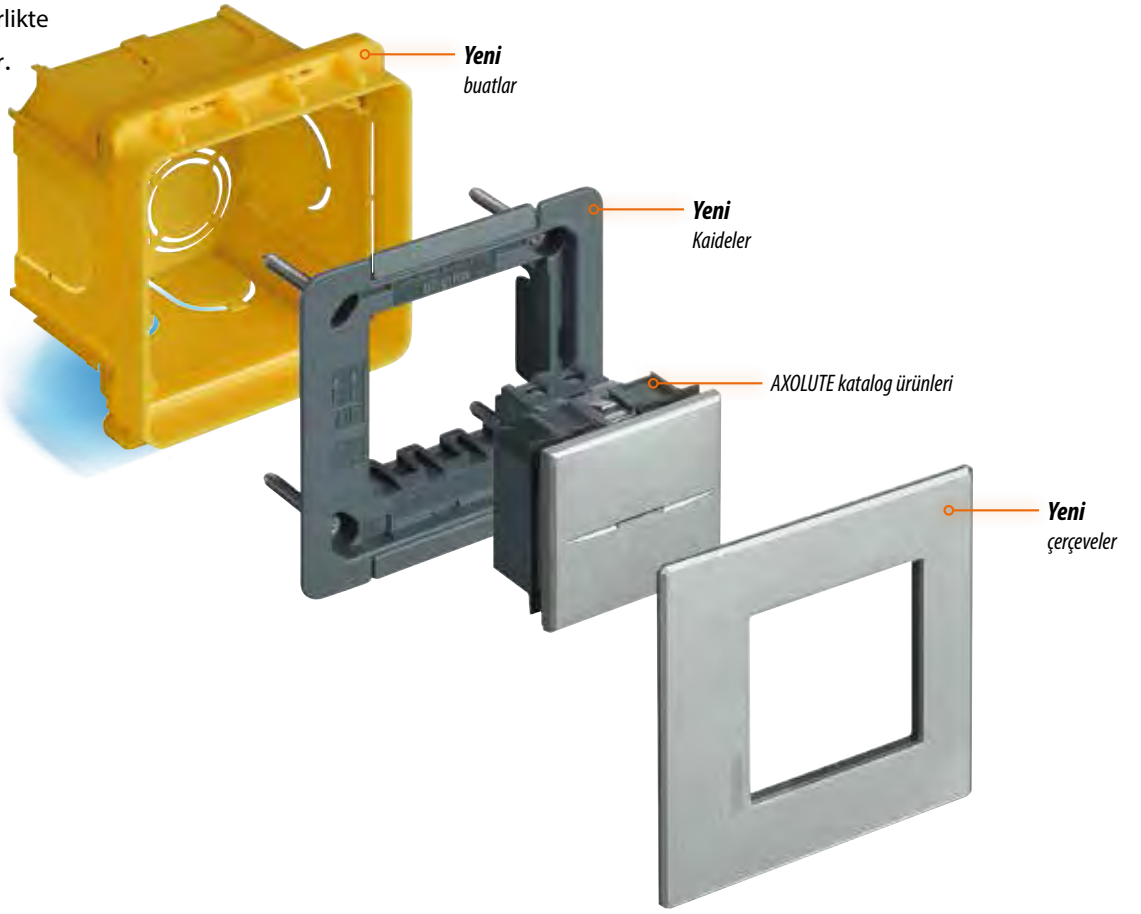

## Geleneksel montaj prosedürleri

- montaj prosedürü geleneksel sistemlerle aynıdır

Axolute Etèris katalogta yer alan bütün modüler AXOLUTE ürünleriyle kullanılabilir.



Örnek: 1 modül ürün



Örnek: 1 ve 2 modül ürün



Örnek: 2 ve 3 modül ürün

# AXOLUTE ETÈRIS: YENİ BUATLAR

## YENİ ÖZEL BUATLAR:

- 2 yeni modüler uygulama (2 ve 8 modül)
- daha derin: anahtarın duvara mükemmel uyumluluğu için

## Geleneksel anahtar prizler kadar kolay montaj

- örme duvar
- alçıpan

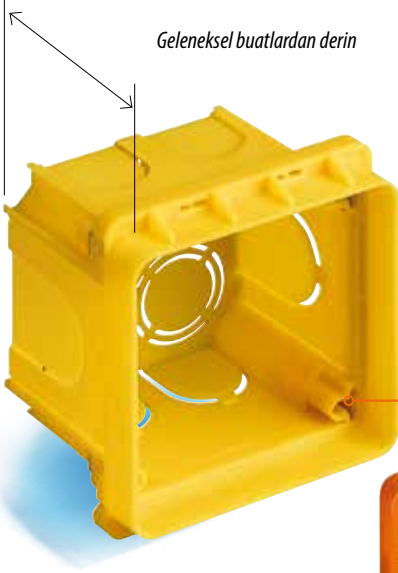

Vida yuvaları çelik plaklarla güçlendirilmiştir.



Sıva koruma kapağı



Su terazisi düzgünlük kontrol.

### ÖRME DUVARLAR İÇİN

2 modül

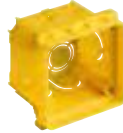

8 modül



### ALÇIPAN DUVARLAR İÇİN

(kalınlık 10 ile 45 mm)

2 modül



8 modül



Etèris buatlar standart buatlardan daha derindir. Sistemi tasarlarken buatların duvara uygun olduğundan emin olun. Ör: standart alçıpan duvarlarda yaklaşık kalınlık 10 cm'dir. Eğer 2 adet Etèris kasa sırt sırta (duvarın iki tarafında aynı yerde) denk gelecek olursa gereken mesafe 12 cm olacaktır. Buda duvarın kalınlığını geçecektir.

# AXOLUTE ETÈRIS: YENİ KAİDELER

Etèris ile bütün muhtemel kombinasyonları iki kaideyle uygulamak mümkün.

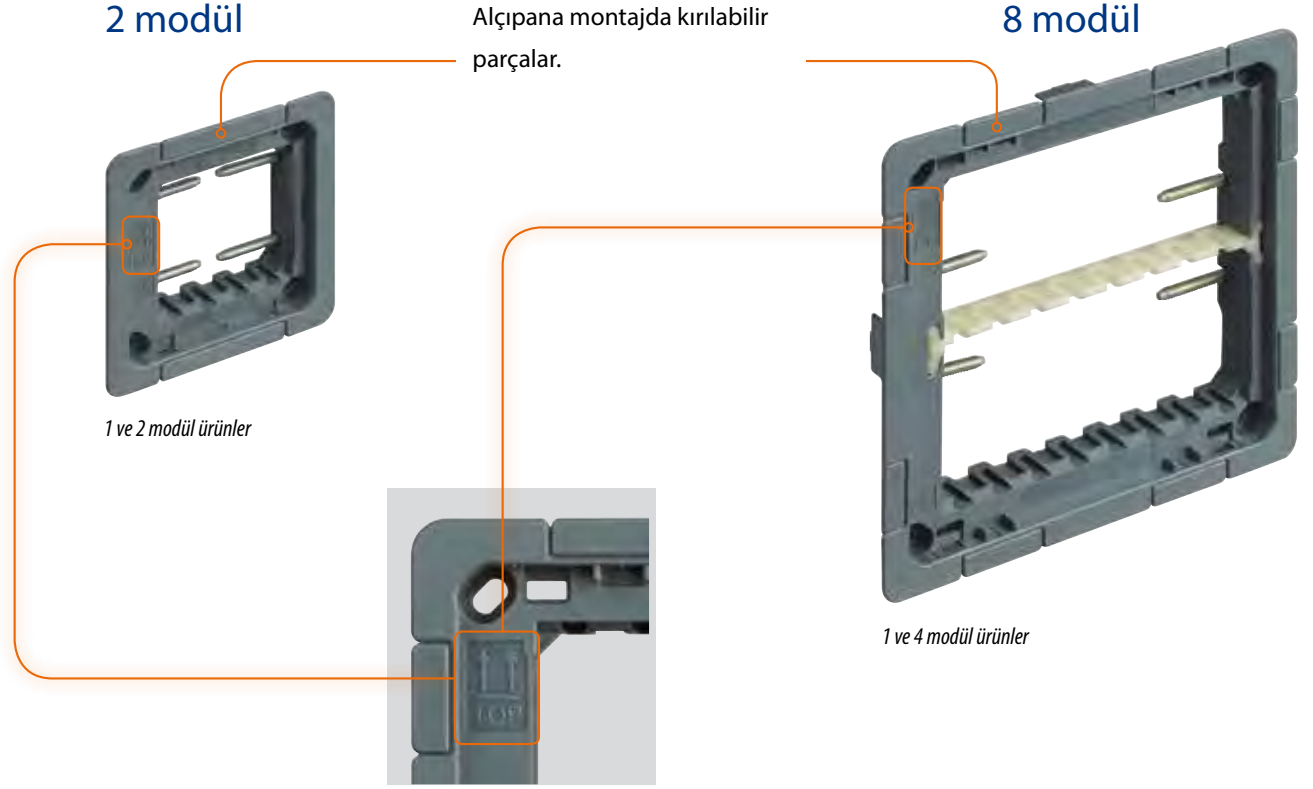

Doğru montaj için kaide üzerindeki ok yönlerine dikkat edin.



Bütün geleneksel AXOLUTE kaideleri gibi, Etèris kaidelerde koruma kapaklarıyla donatılmıştır.

# AXOLUTE ETÈRIS: YENİ ÇERÇEVELER

- 2 format
- 3 renk (beyaz, alüminyum, antrasit)

## UFAK FORMAT



2 modül

## BÜYÜK FORMAT



4 modül

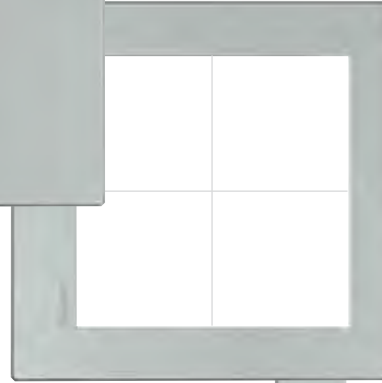

8 modül

sadece 2.5 mm kalınlık



Dokunmatik ekran ve Video Display çerçeve



Çerçeve altında izolasyon kullanmak zorunludur

4 ve 8 modül çerçeveler mekanizmanın çerçevesinde güvenliğini sağlamak için ayrı bir izolasyon plakası kullanılmalıdır.

## Çerçeveleri çıkartmak

Sabitlenmiş çerçeveyi çıkarmak için, **H4802KY çerçeve çıkarma aparatını** kullanın.

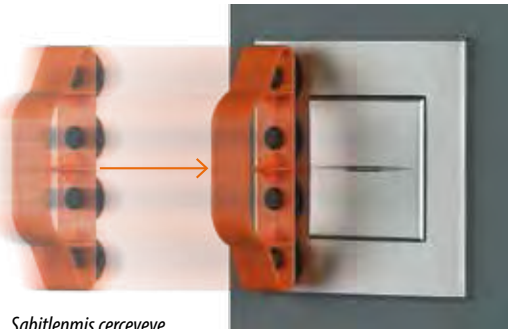

Sabitlenmiş çerçeveye yapışana kadar çerçeve çıkarma aparatını bastırın.



Çekin ve çerçeveyi çıkarın.



# AXOLUTE ETÈRIS: MONTAJ PROSEDÜRLERİ

## Örme duvara montaj

Örme duvara buat montajı optimum görsel sonuca ulaşmak açısından ciddi önem taşır.

1



Buatı duvar boşluğuna yerleştirin.  
502WBI referanslı aksesuarı kullanarak buat seviyesini belirleyin.



2



Duvarı alçılavin boyayın. İşlem sona erdiğinde, buatlar duvar üzerinde çıkıntı yapmamalıdır.

3



502CW ya da 528CW referanslı kapakları kullanarak buat çevresindeki duvar hatalarını düzeltin.

4



Kaideyi yerleştirin.  
Gerekirse koruma aparatını kullanın.



5



Tamamlanmış anahtar.

Not: Yukardaki prosedür 2 modül ve 8 modül buatlar için geçerlidir

## Duvar kaplamaları

Etèris montajını kaplama duvarlara yapmak için, örme duvar montaj prosedürlerinin 1. ve 2. adımını tekrarladıktan sonra aşağıda belirtilen adımları gerçekleştirin.



Siva koruma kapağını çıkardıktan sonra, 502CW veya 528CW koruma kapağını monte edin.



Koruma kapağını yerleştirin.

*Koruma kapağını şablon olarak kullanabilirsiniz.*



Tamamlanmış montaj.



Kaideyi yerleştirin kaide, duvarın üst bölümüne yerleştirilebilir gerekirse koruma aparatını kullanın.



Tamamlanmış anahtar.

# AXOLUTE ETÈRIS: MONTAJ PROSEDÜRLERİ

## Alçıpan duvara montaj

1



2 modül ve 8 modül buatlarla temin edilen yapışkanlı etiketler, alçıpanı doğru yerden kesmenize yardımcı olur.

2



Açılan boşluğa buatı yerleştirin ve kullanarak sabitleyin.

3



Kırılabilir bölmeleri kırarak kaideyi hazırlayın.

4



Kaideyi buata monte edin.



Gerekirse koruma aparatını kullanın.

5



Tamamlanmış anahtar

## 2 MODÜL BUATLAR - MODÜLERLİK

### Birleştirilebilen çerçeveler

2 modül birleştirilebilen buatlarla, ihtiyaca ya da isteğe göre, Etérés mekanizmaları **bir arada** kullanılarak anahtar/priz kombinasyonları oluşturabilir.

Montaj tamamlandıktan sonra, çerçeve birleşimleri de kusursuz bir şekilde gerçekleşir.

3 çerçevenin yatay konfigürasyonu



2 çerçevenin dikey konfigürasyonu



### BUATLARIN BİRLEŞTİRİLMESİ

Bu işlem 502WA referanslı kuplör kullanılarak **örme duvar** ve **alçıpan** duvarlarda da uygulanabilir. Sonraki sayfalarda ayrıntılı olarak anlatılacak olan adımlar gerçekleştirilerek çok kolay bir şekilde birleştirilebilir.

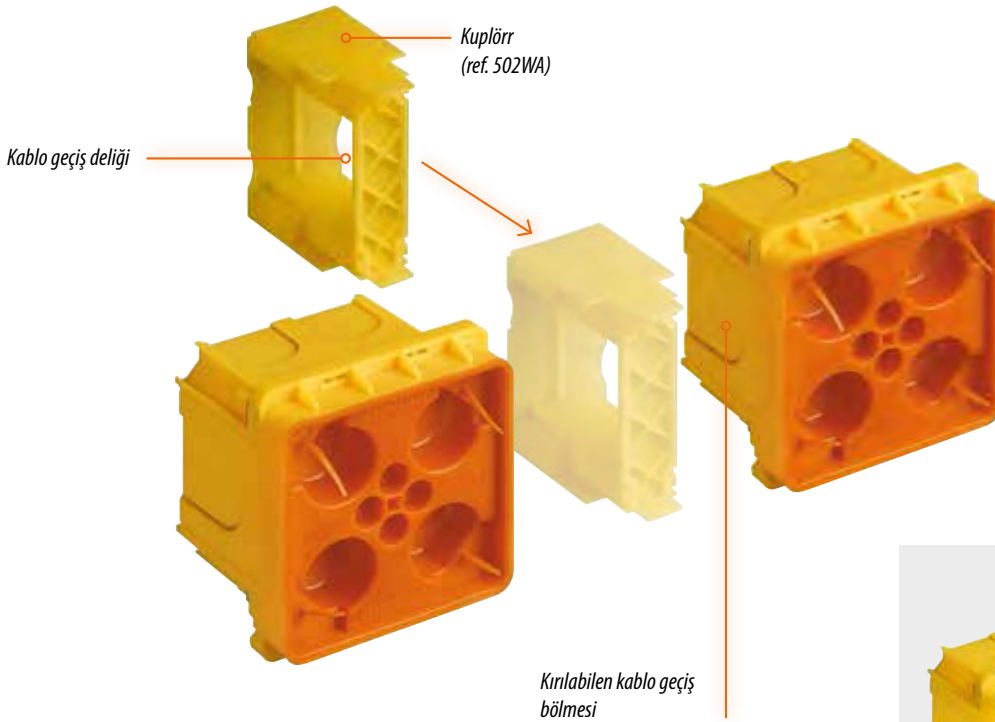

Kuplörler içinden geçen kablolarla buatlar birleştirilebilir.



# 2 MODÜL BUATLAR -MODÜLERLİK

## Örme duvara montaj

1



Buati duvara yerleştirdikten sonra, 502WBL referanslı aksesuarı kullanarak yüzeyin düzgün olduğundan emin olun.

2

Duvarı alçıl原因 ve boyayın. İşlem sona erdiğinde buatlar duvar üzerinde çıkıntı yapmamalıdır.



### KAİDELERİN HİZALANMASI VE MONTAJI

Örme duvar koruma kapaklarını kaldırdıktan ve uygun aksesuarı kullanarak duvar yüzeyindeki pürüzleri düzelttikten sonra, **vidaları sıkmadan kaideleri**

**yerleştirin.** 502WD referanslı şablonu kullanarak **kaideleri hizalayın.** Daha sonra vidaları sıkarak kaide konumunu sabitleyin. Kaideleri sabitledikten sonra, normal prosedüre uygun anahtar montajını yaparak işlemi sonlandırın.

3



Sıkılmamış vida

Vidaları sıkmadan önce şablonu doğru pozisyona getirin ve ilk 2 kaidelyi bu şablona göre hizalayın vidaları sıkılaştırın.

4



Kaideleri hizalayın ve sabitleyin

## Alçıpan duvara montaj

1

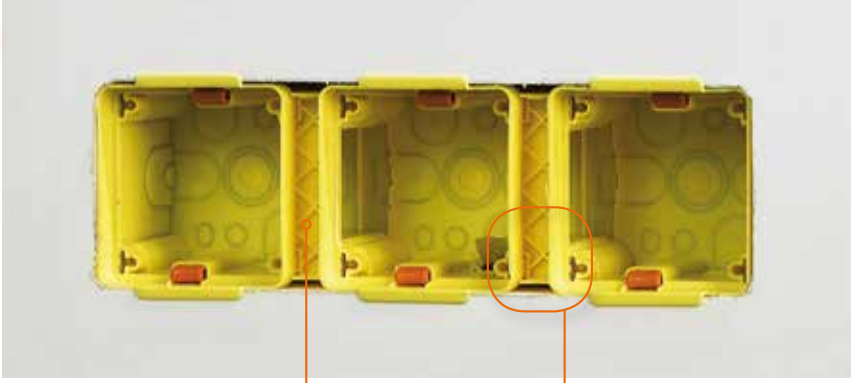

Dolgu malzemesi ile doldurulacak boşluklar

Alçıpanı kesip, buatları yerleştirdikten sonra, dolgu malzemesi kullanarak buatlar arasındaki boşlukları doldurun.

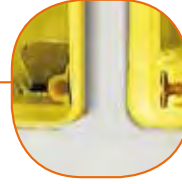

2

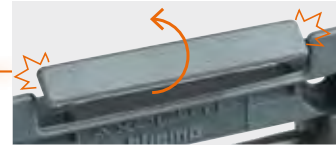

Kırılabilir bölmeleri çıkartarak kaideyi hazırlayın.

### KAİDELERİN HİZALANMASI VE MONTAJI

**Vidaları sıkmadan** kaideleri yerlerine yerleştirin. Kaideleri **hizalamak**, için 502WD referanslı şablonu kullanın.

**Vidaları sıkarak** kaide konumlarını sabitleyin. Kaideleri sabitledikten sonra normal prosedüre uygun anahtar montajını yaparak işlemi sonlandırın.

3



Sıkılmamış vida



Vidaları sıkmadan önce, şablonu doğru pozisyona getirin ve ilk 2 kaideyi bu şablona göre hizalayın. Vidaları sıkın.

4



Kaideleri hizalayın ve sabitleyin



# 2 MODÜL BUATLAR MODÜLERLİK

## Ayrı çerçeveler

Tüm duvar çeşitlerinde anahtarlara, dikey ya da yatay olarak, birbirleri arasında belirli bir **mesafe** bırakılarak yerleştirilebilirler.

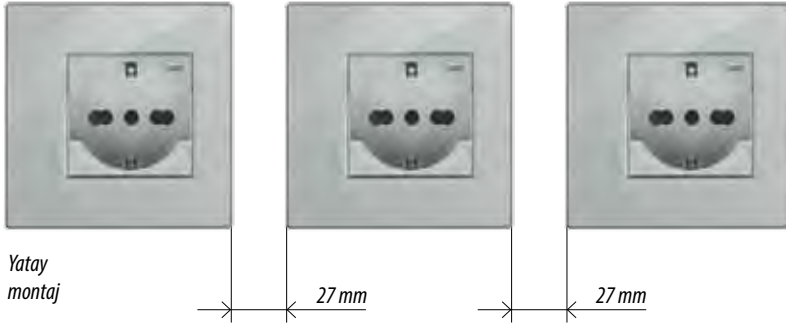

*BTicino aksesuarları kullanılarak çerçeve montajları yapıldıktan sonra çerçeveler arasındaki mesafe 27 mm olacaktır.*

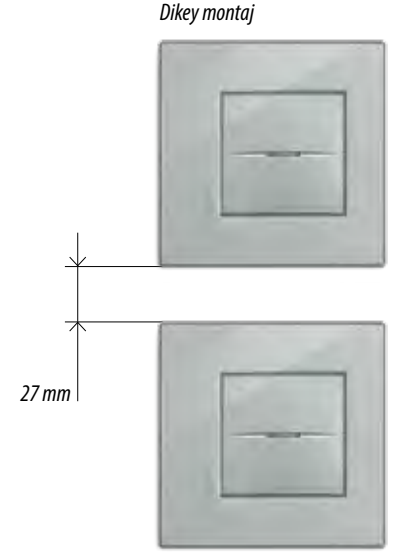

### ÖRME DUVAR

Uygun olan birleştirme aksesuarı kullanılarak belirli **mesafede** montaj yapılabilir. Bu aksesuar 503ED referans numarası ile katalogta yer almaktadır.

#### Not

Birleştirilebilen buatlarla tekli buatların montaj prensipleri aynıdır.

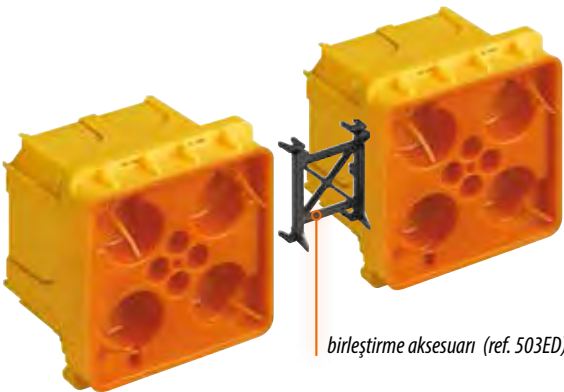

*birleştirme aksesuarı (ref. 503ED)*

**Not:** Ref. 503ED 8 modül buatlarlada kullanılabilir.

### ALÇIPAN DUVAR

Buatlarla birlikte temin edilen yapıştırılabilir etiketler kullanılmamalıdır.

#### Not

Alçıpan kesildikten sonra birleştirilebilen buatlarla tekli buatların montaj prensipleri aynıdır.

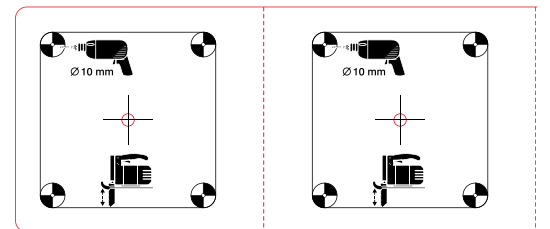

*Doğru montaj için, etiketi buat üzerindeki doğru alçıpan seçeneği üzerine getirin.*

## İÇİNDEKİLER

## AXOLUTE ETÈRIS

KATALOG	160
Montaj şemaları	162
Çerçevesel	164

# AXOLUTE ETÈRIS KATALOG



HW4684

## DOKUNMATİK EKRAM

Ref. Tanım

**HW4684** Monoblok Etèris dokunmatik ekran. Sadece, 528W (örme duvar) ve PB528W (alçıpan) buatlarla birlikte monte edilebilir. MY HOME işlevlerinin bulunduğu odaya yerleştirilirse oda kontrolü. Senaryoları aydınlatma, otomasyon, hırsız alarm, sıcaklık ve enerji yönetimi için arayüz.



349340

## ETÈRIS VIDEO DISPLAY

Ref. Tanım

**349340** Monoblok Etèris video display. Sadece 528W (örme duvar) ve PB528W (alçıpan) buatlarla monte edilebilir. HW4826HC, HW4826HS, ve HW4826HD referanslı tuş kapakları ile tamamlanır. Katalogta yer alan 349311, 349312 ve 349313 referanslı video Displaylerle aynı işlevlere sahiptir.

**349243** Video display tuş kapağı, beyaz, ref. 349340

**349241** Video display tuş kapağı, alüminyum

**349242** Video display tuş kapağı, antrasit



349243



349241



349242

## ETÈRIS VIDEO DISPLAY

349340 referanslı video display bu 3 ön kapaktan bir tanesi ile tamamlanmalıdır..

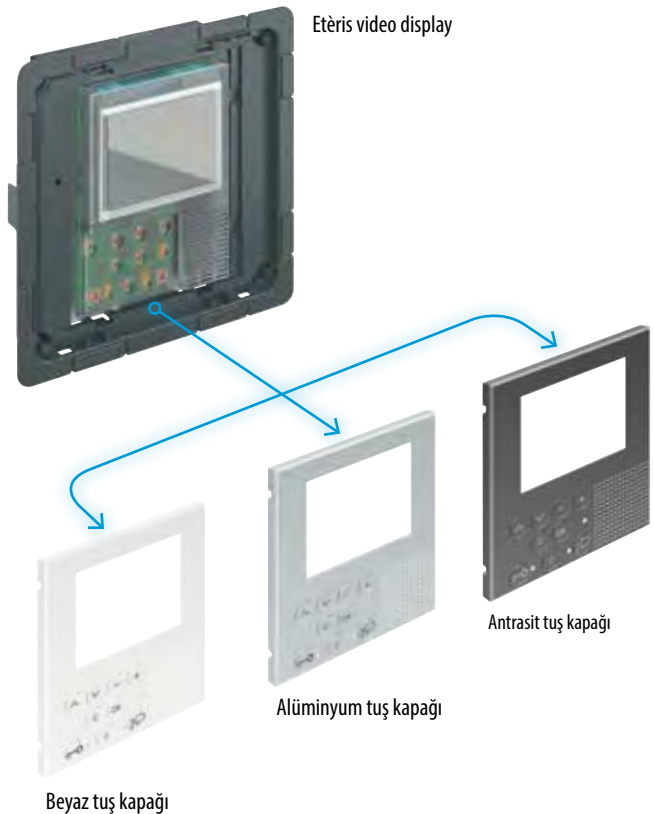

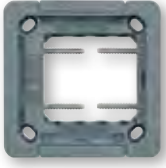

H4702W

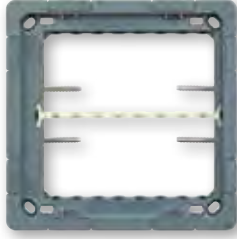

H4728W



502W



528W



PB502W



PB528W



H4802KY



502WBL



502CW



528CW

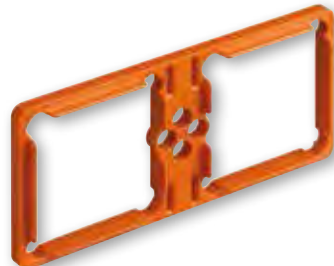

502WD



502WA



503ED

### KAİDELER

Ref.	Tanım
<b>H4702W</b>	Koruma kapaklı 2 modül kaide 502W (örme duvar) ve PB502W (alçıpan) buatlarla kullanılabilir.
<b>H4728W</b>	Koruma kapaklı 8 modül kaide. 528W (örme duvar) ve PB528W (alçıpan) buatlarla kullanılabilir.

### BUATLAR

Ref.	Tanım
<b>502W</b>	2 modül sıva altı buati, örme duvar için, sıva koruma kapağı ile birlikte temin edilir.
<b>528W</b>	8 modül sıva altı buati, örme duvar için, sıva koruma kapağı ve iş bölme ile birlikte temin edilir.
<b>PB502W</b>	2 modül sıva altı buati, alçıpan için, sabitleme dili ile birlikte temin edilir.
<b>PB528W</b>	8 modül sıva altı buati, alçıpan için, sabitleme dili ve iç bölmeler ile birlikte temin edilir.

### AKSESUARLAR

Ref.	Tanım
<b>H4802KY</b>	Çerçeve çıkartma aparatı.
<b>502WBL</b>	Seviye belirleyici, buatların yerleştirilmesi ve doğru kaide hizalanması için.
<b>502CW</b>	2 modül buatların yerleştirilmesi için kullanılan 2 modül koruma kapak koruma.
<b>528CW</b>	8 modül buatların yerleştirilmesi için kullanılan 8 modül kapak aynı zamanda duvar yüzeyindeki hataları gidermek için kullanılabilir.
<b>502WD</b>	Birleştirilebilir montajlarda kullanılan 2 modül kaideleri hizalamak ya da alçıpan duvarlarda doğru konumu belirtmek için şablon.
<b>502WA</b>	Kuplör, buatların birleştirilmesini sağlar. 2 modül alçıpan ve örme duvar buatların en iyi şekilde hizalanmasını ve birleştirilmesini sağlar.
<b>503ED</b>	Örme duvar için birleştirme aksesuarı (502W ve 528W) montaj sonlandırdıktan sonra çerçeveler arasındaki mesafe 27 mm'dir.

**Not:** Bu sayfadaki referanslar AXOLUTE ETÉRIS'e özel referanslardır. Diğer ürün referansları için AXOLUTE kataloğuna başvurunuz.

# AXOLUTE ETÈRIS MONTAJ ŞEMASI

## 2 ve 4 modül

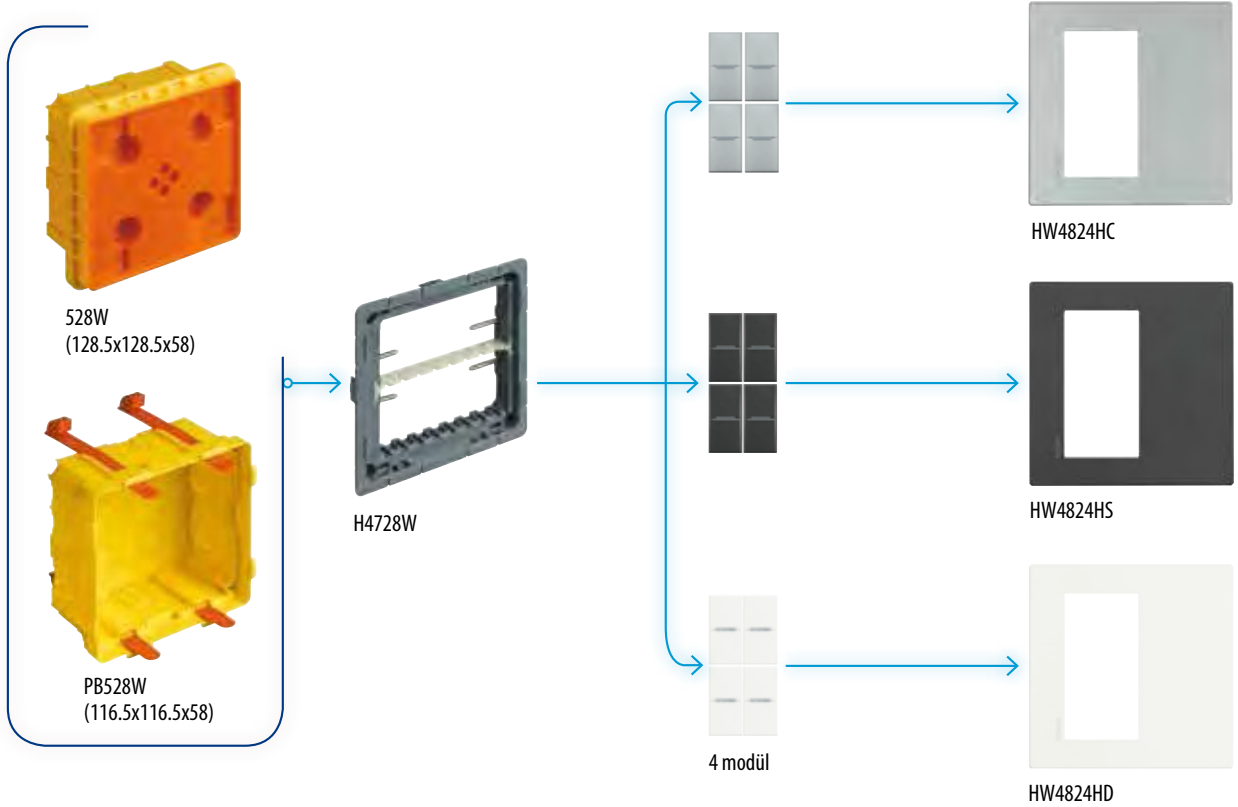
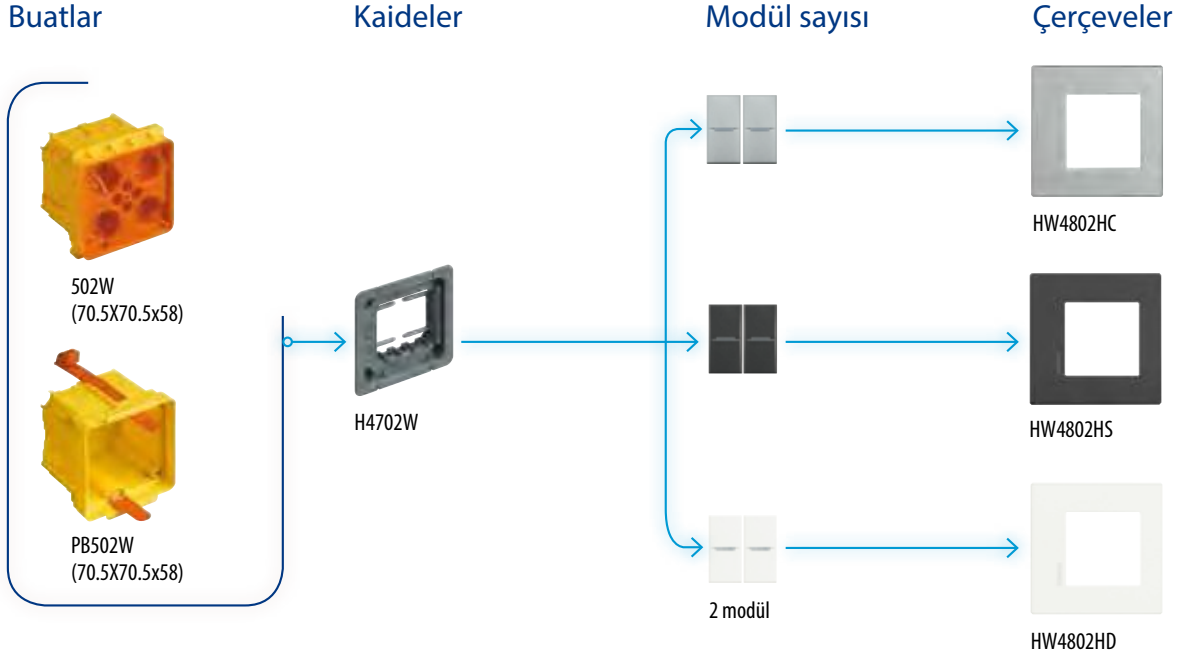

## 8 modül, Dokunmatik ekran ve Video Display

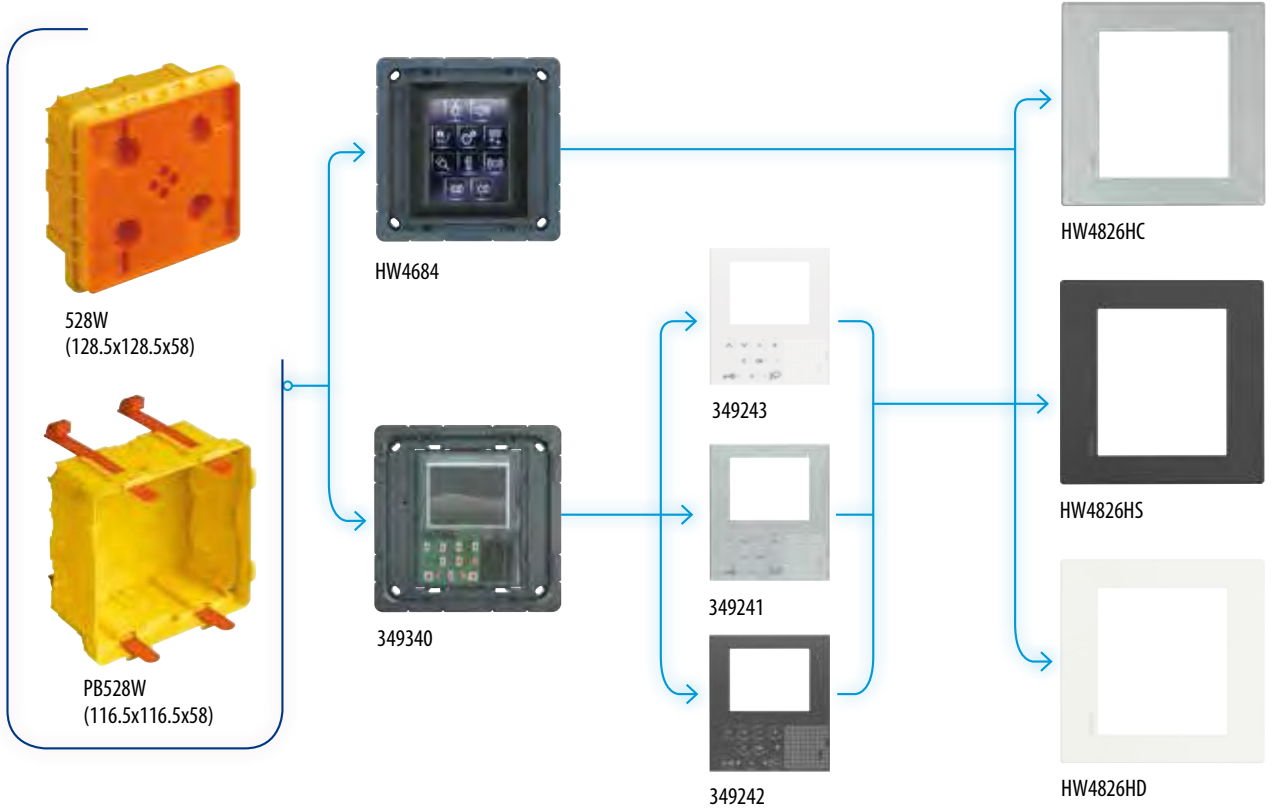
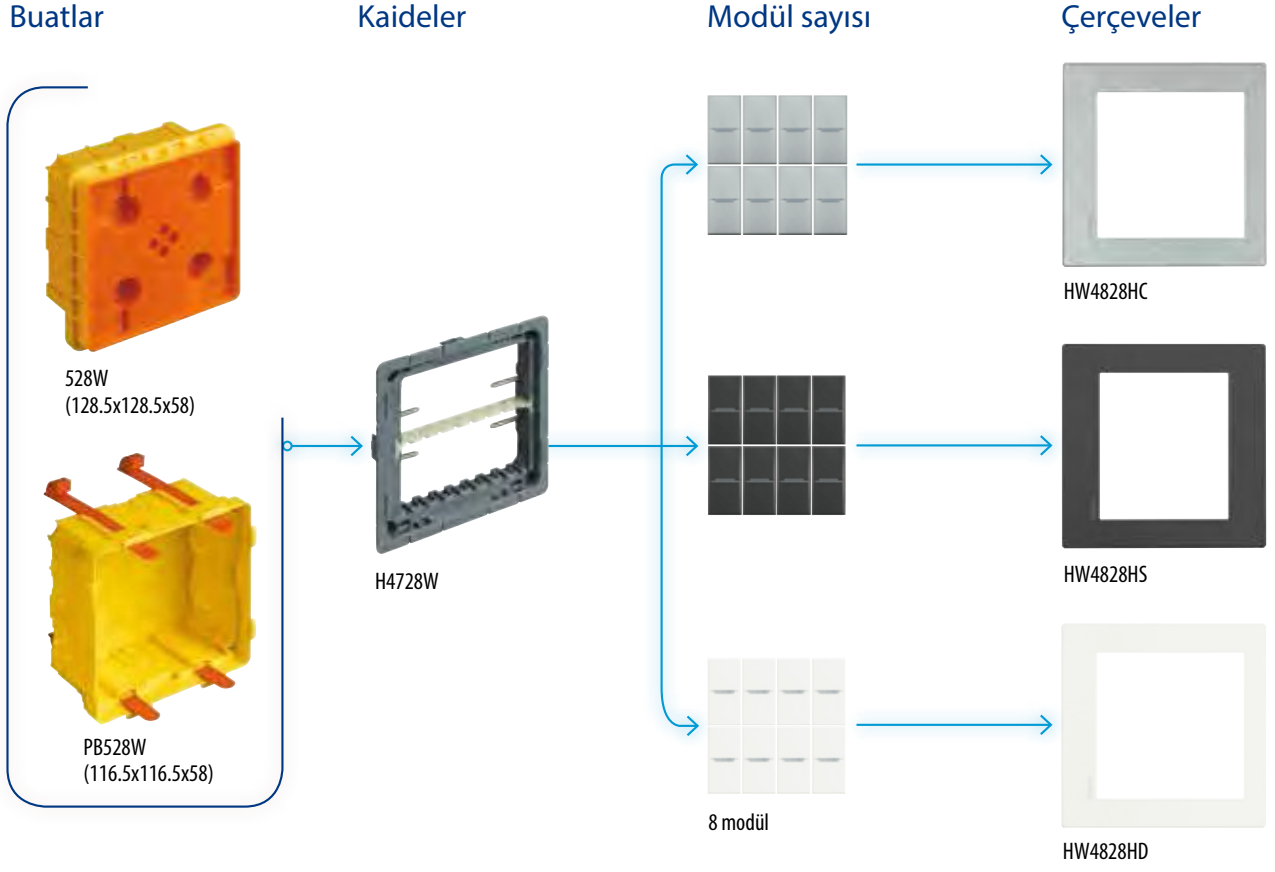



# AXOLUTE ETÈRIS ÇERÇEVELER

2 MODÜL

Beyaz

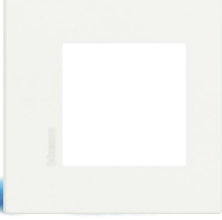

HW4802HD

Alüminyum



HW4802HC

Antrasit



HW4802HS

4 MODÜL

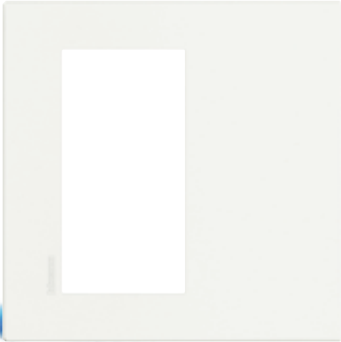

HW4824HD



HW4824HC

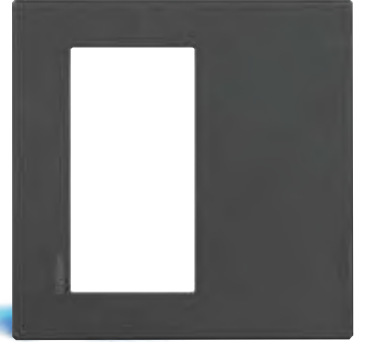

HW4824HS

8 MODÜL

Beyaz

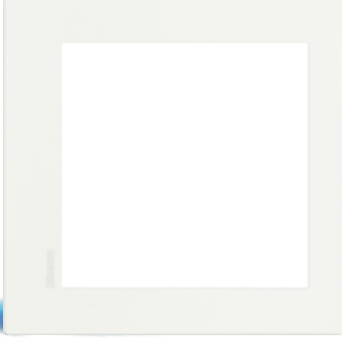

HW4828HD

Alüminyum



HW4828HC

Antrasit



HW4828HS

DOKUNMATİK EKРАНLAR VE VİDEO DİSPLAY

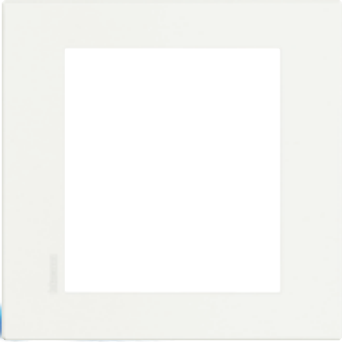

HW4826HD



HW4826HC



HW4826HS

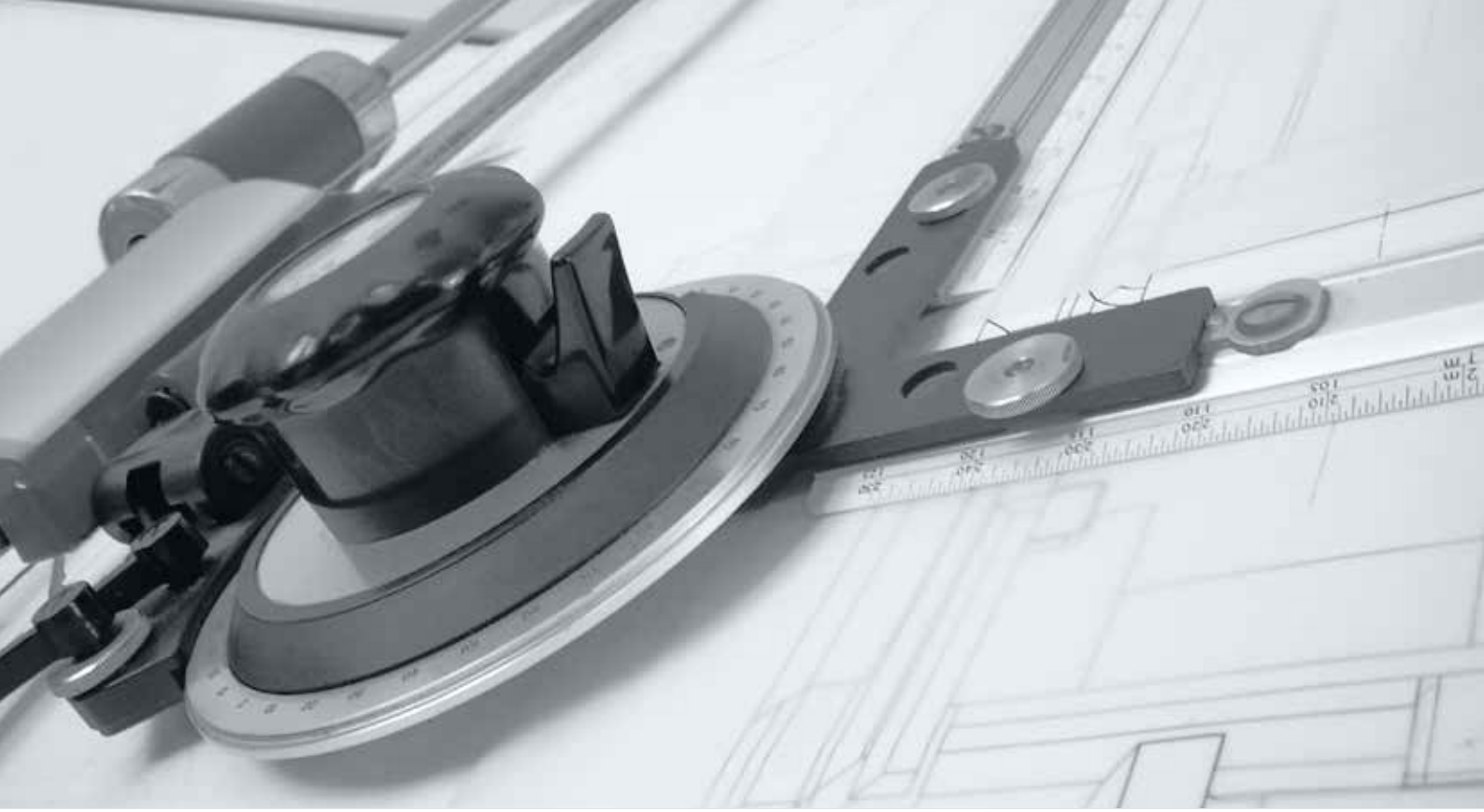

**İÇİNDEKİLER****ÖLÇÜLER**

Dikdörtgen çerçeveler .....	168
Eliptik çerçeveler .....	170
Axolute Etèris çerçeveler .....	171
Axolute Etèris buatlar .....	172
Ürünler .....	173

# ÖLÇÜLER

## AXOLUTE dikdörtgen çerçeveler

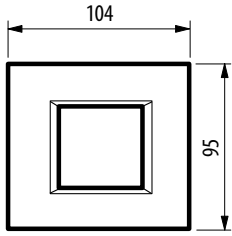

HA4802...

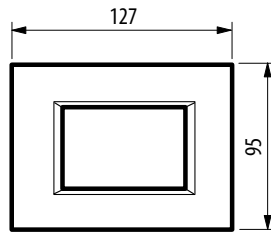

HA4803... - HC4657M3  
HA4829... - HS4657M3

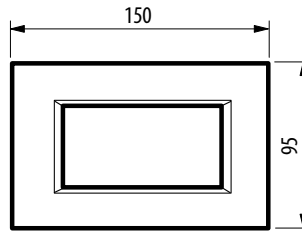

HA4804... - HC4657M4  
- HS4657M4

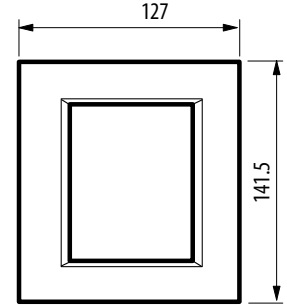

HA4826...

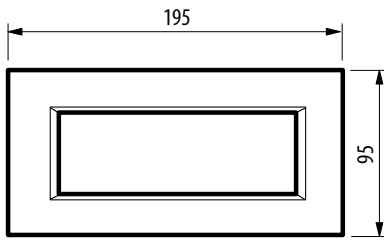

HA4806...

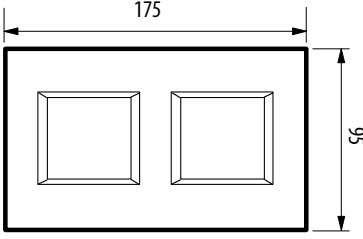
**MERKEZLER ARASI 71 MM - YATAY**

HA4802M2H...

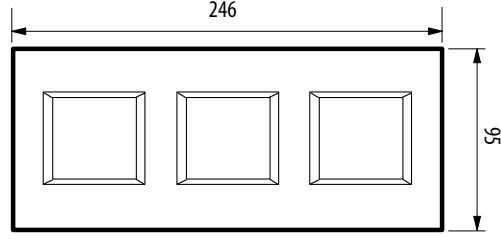

HA4802M3H...

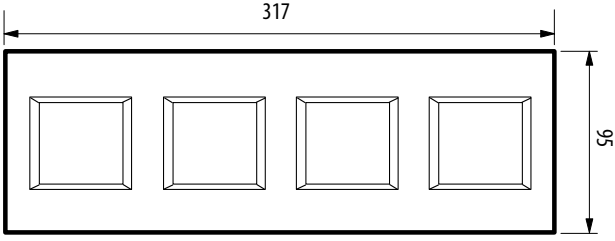

HA4802M4H...

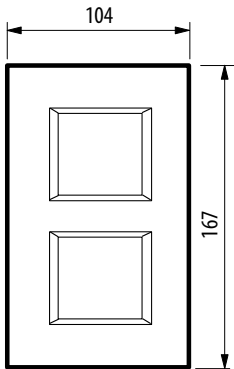
**MERKEZLER ARASI 71 MM - DİKEY**

HA4802/2... - HA4802M2...

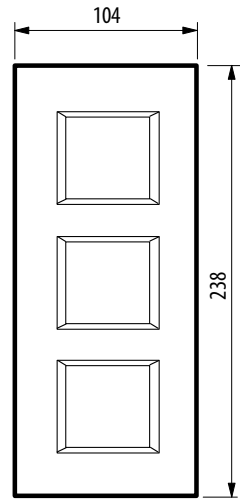

HA4802/3... - HA4802M3...

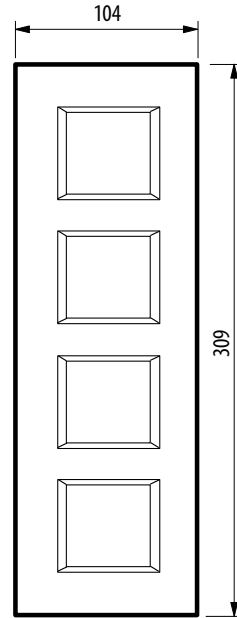

HA4802/4... - HA4802M4...



# ÖLÇÜLER

## AXOLUTE eliptik çerçeveler

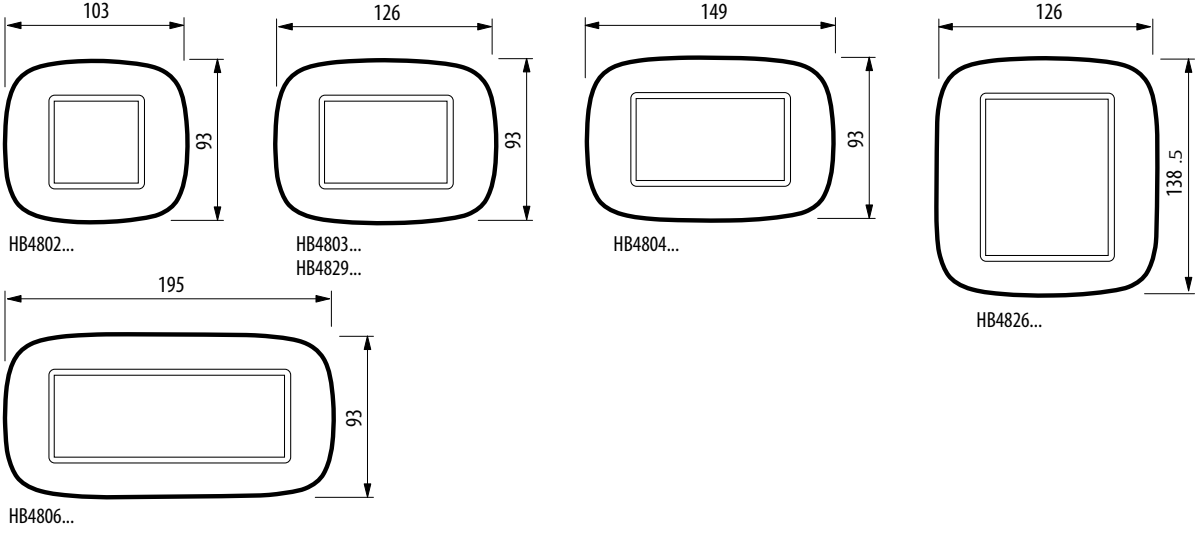

### MERKEZLER ARASI 71 MM - YATAY/DİKEY

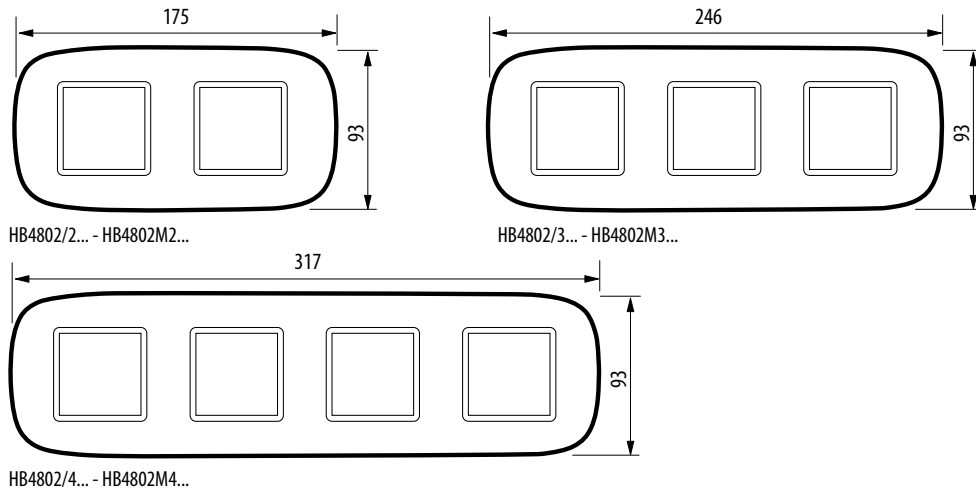

## AXOLUTE ETÈRIS çerçeveler

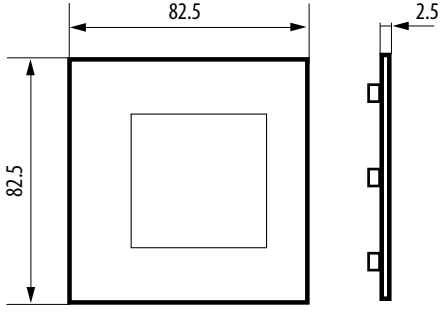

HW4802HC - HW4802HD - HW4802HS

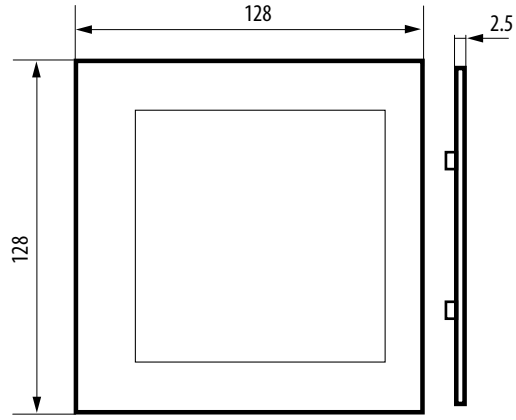

HW4828HC - HW4828HD - HW4828HS

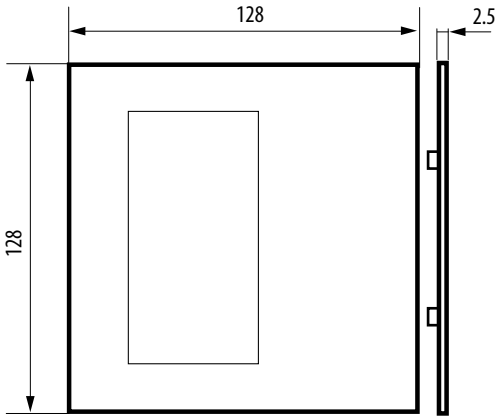

HW4824HC - HW4824HD - HW4824HS

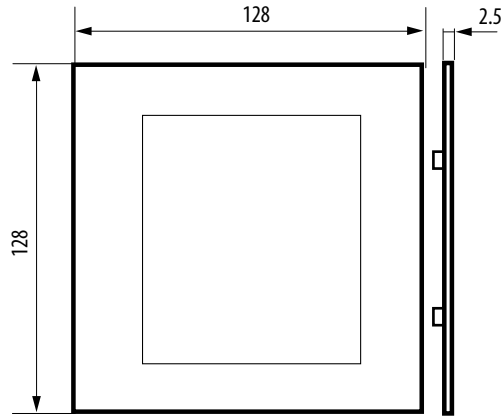

HW4826HC - HW4826HD - HW4826HS

# ÖLÇÜLER

## AXOLUTE ETÈRIS buatlar

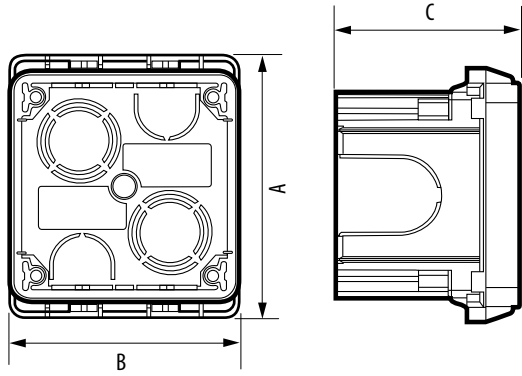

502W

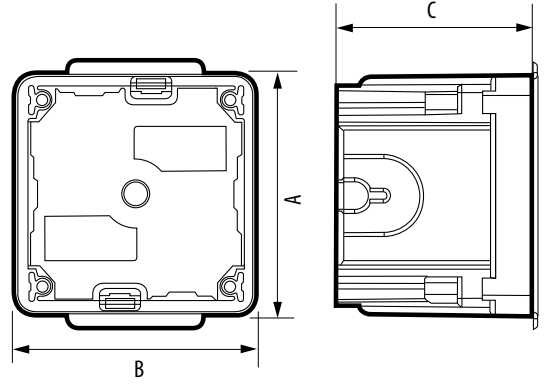

PB502W

Ölçüler (mm)	a	b	c
<b>502W</b>	80	70.5	58
<b>PB50W</b>	70.5	70.5	58

## ALÇIPAN

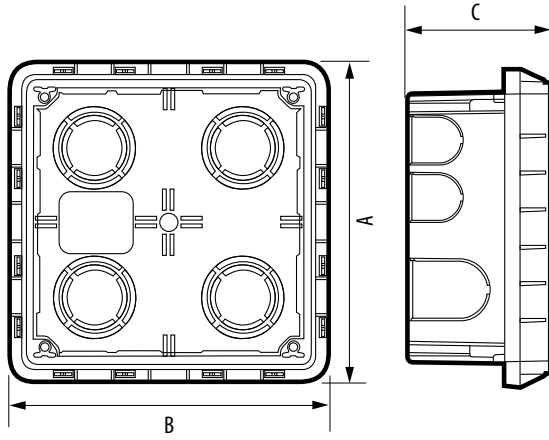

528W

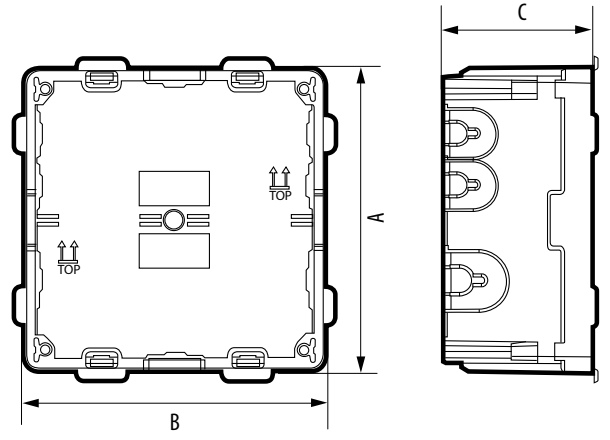

PB528W

Ölçüler (mm)	a	b	c
<b>528W</b>	128.5	128.5	58
<b>PB528W</b>	116.5	116.5	58

## Ürünler

### MODÜLER ÜRÜNLER

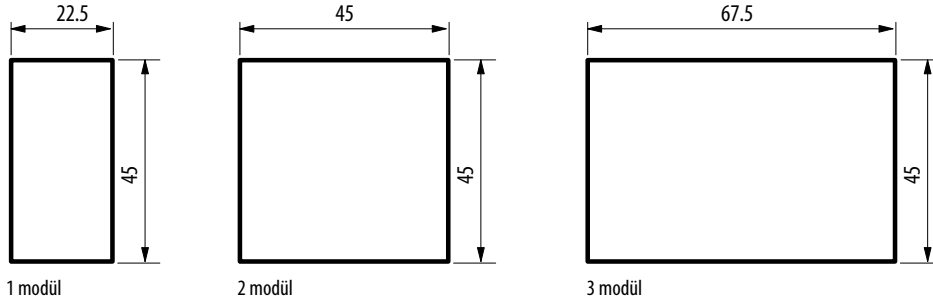

### DIN ÜRÜNLER

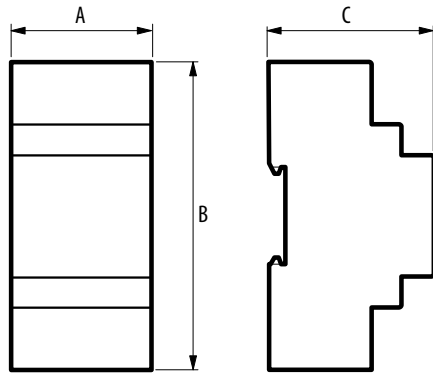

DIN ölçüleri (mm)

Modül sayısı	A	B	C
1	17.5		
2	35		
3	52.5		
4	70		
5	87.5	90	60 / 61
6	105		
7	122.5		
8	140		
9	157.5		
10	175		

### MODÜLER OLMAYAN ÜRÜNLER

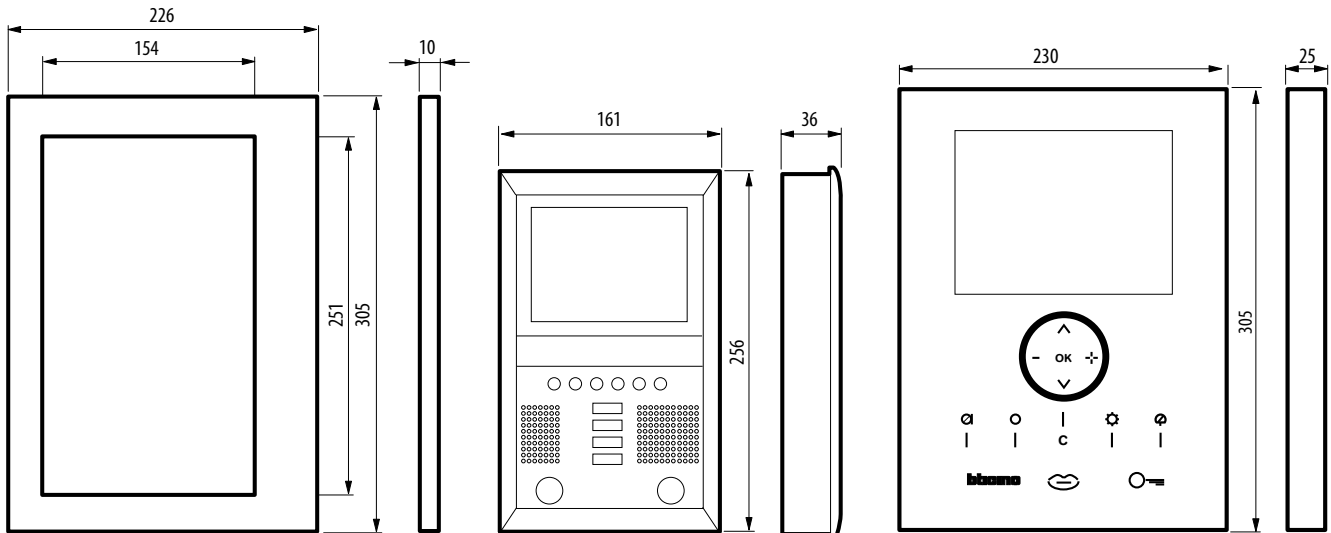

# ÖLÇÜLER

## MODÜLER OLMAYAN ÜRÜNLER

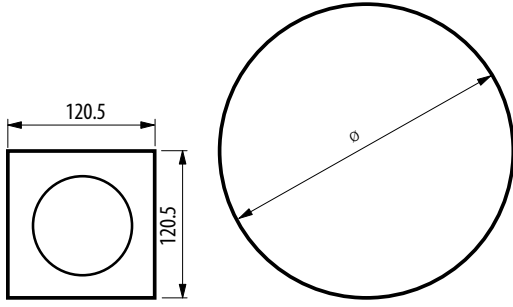

HC-HS4565  
HC-HS4070

L4566 - Ø240  
L4566/10 - Ø100

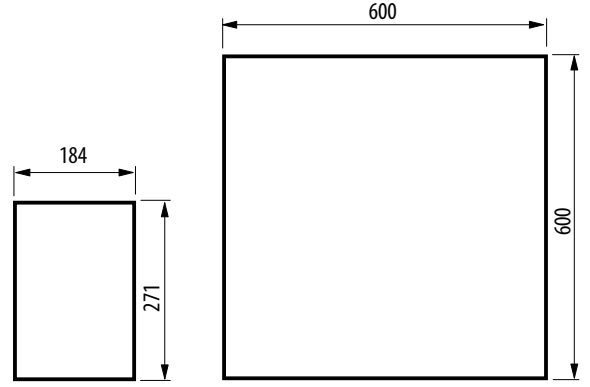

L4567

L4568

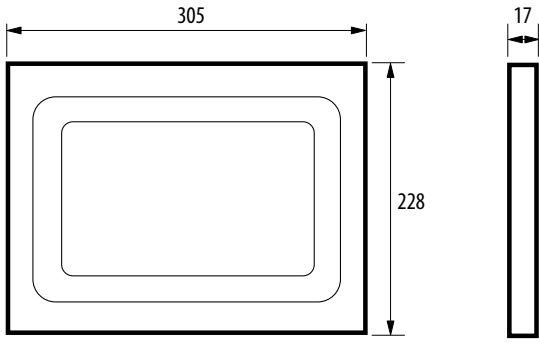

HD-HC-HS4690

## ÜRÜNLER

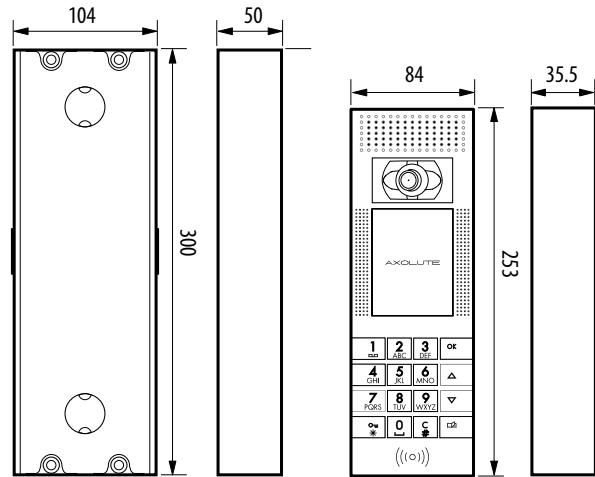

339313

349140

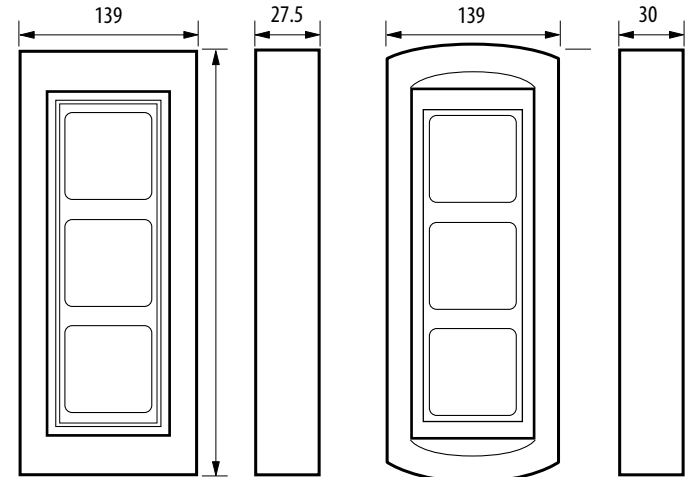

339213

339223







## ELTAŞ ELEKTRİK MALZ. SAN. ve PAZ. A.Ş.

### Pazarlama Müdürlüğü ve İstanbul Bölge Satış Müdürlüğü

Evliya Çelebi mah.

Sadi Konuralp cad. No: 1

34430 Şişhane - İSTANBUL

Tel : (212) 368 28 00 (pbx)  
(212) 251 34 30

Faks : (212) 251 52 95 - 249 39 91

e-posta: info@bticino.com.tr



@ www.bticino.com.tr

f www.facebook.com/BTicinoTurkiye

www.twitter.com/BTicinoTurkiye

### Adana Bölge Satış Müdürlüğü

Turhan Cemal Beriker Bulvarı  
Gizerler İş Merkezi A Blok Kat: 3 No: 6  
01110 ADANA  
Tel : (322) 458 46 26 (pbx)  
Faks : (322) 458 26 80

### Ankara Bölge Satış Müdürlüğü

Sanayi Cad. Çavuş sok, Akgül İşhanı No: 3  
D:10 06050 Ulus - ANKARA  
Tel : (312) 310 92 14 - 310 82 15  
(312) 309 18 32 - 309 18 33  
Faks : (312) 312 28 88

### Bursa Bölge Satış Müdürlüğü

Üçevler mah. Bayraktepe sok.  
Akay İş Merkezi No: 7 D: 5  
Nilüfer - BURSA  
Tel : (224) 443 28 00  
(224) 443 01 03  
(224) 443 01 04  
Faks : (224) 443 01 05

### İzmir Bölge Satış Müdürlüğü

1203/11. Sokak Ömer Atlı İş Merkezi  
No: 3 Kat: 7 D: 708-709  
35110 Yenisehir - İZMİR  
Tel : (232) 469 23 33  
Faks : (232) 469 26 66

### Diyarbakır Satış İrtibat

Tel : (412) 235 74 83  
Faks : (412) 235 74 83  
GSM : (533) 968 16 79

### Karadeniz Satış İrtibat

Faks : (462) 229 99 54  
GSM : (533) 296 62 59